

eSPORTS

# LS25

WIRED GAMING HEADSET  
CASQUE DE JEU FILIARE

*Tournament Edition*



USER GUIDE  
GUIDE D'UTILISATION  
BEDIENUNGSANLEITUNG  
GUÍA DE USO  
MANUALE D'USO



EN

# HEADSET



[L]

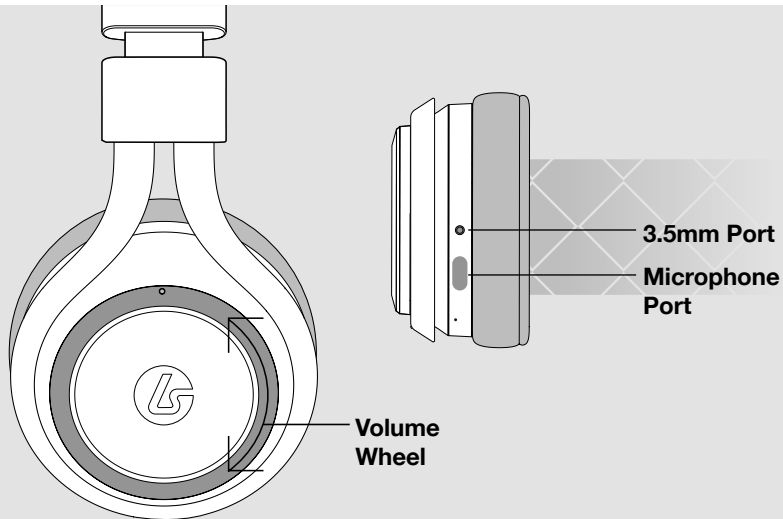

[R]

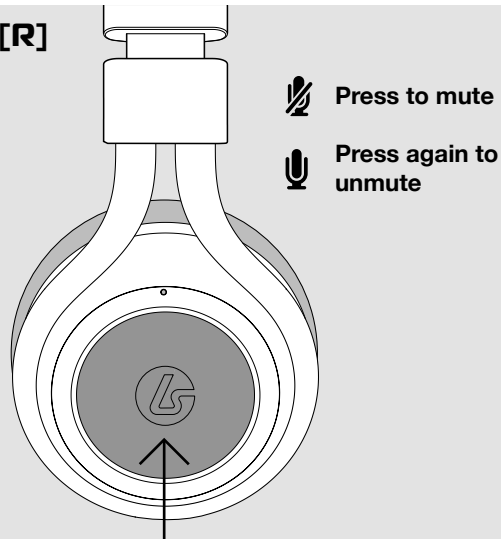



**1** Boom Mic



**3** 3.5mm to PC cable

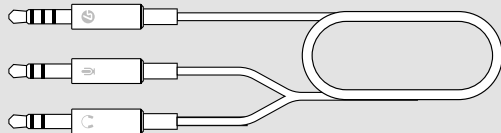

**2** Mobile / Console cable

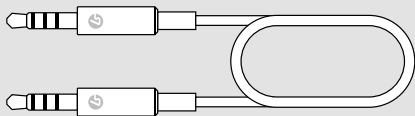

**4** Wind Sock

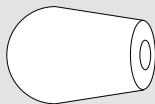

**5** Mic Port Cover



EN

## MICROPHONE



The LS25 includes an optional boom microphone. When this microphone is removed, an internal microphone is activated.

To connect the boom microphone, insert it into the port on the bottom of the headset.

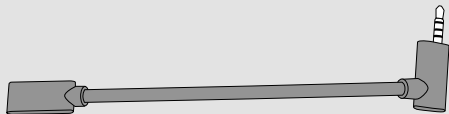
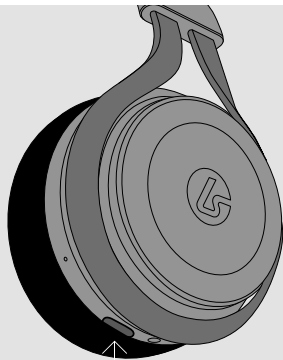

## PLAYSTATION 4 SETUP



- 1 Go into **Settings > Devices > Audio Devices** and set the 'Output to Headphone' to 'All Audio'.
- 2 Set the 'Volume Control (Headphones)' to maximum.  
You can now use the controls on the headset to adjust volume and mute.

## MOBILE SETUP



Connect one end of the mobile cable to the 3.5mm input on the headset and the other end to the 3.5mm output on the mobile device.

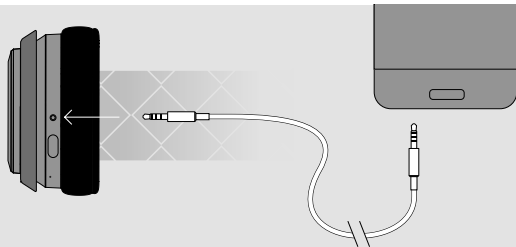

## Controllers with 3.5mm port

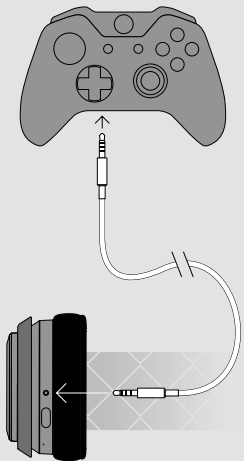

- 1 Connect one end of the Xbox One chat cable to the 3.5mm port on the headset and the other end to the 3.5mm port on the Controller.
- 2 Press the Xbox Guide button and navigate to the gear icon. Then, scroll down and select **'Audio.'**
- 3 Set **'Headset volume'** to maximum. Make sure that **'Headset mic'** is turned to **'On'**.
- 4 Set **'Headset chat mixer'** for the desired level of game and chat audio balance (default is 50%). You can now use the controls on the headset to adjust volume and mute.

## Controllers without 3.5mm port

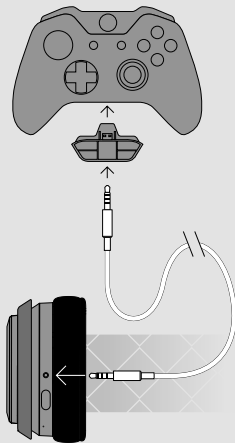

**If the Xbox One Controller does not have a 3.5mm port, an Xbox One Stereo Headset adapter is required (not included).**

- 1 Connect one end of the Xbox One chat cable to the 3.5mm port on the headset and the other end to the 3.5mm port on the Stereo Headset Adapter.
- 2 Adjust the game/chat balance on the Stereo Headset Adapter for the desired level of chat and game audio balance.
- 3 Adjust the volume on the Stereo Headset Adapter to Maximum. You can now use the controls on the headset to adjust volume and mute.

## For computers with separate headphone and mic ports

- 1 Connect the single jack end of the 3.5mm to PC cable to the 3.5mm port on the headset.
- 2 Connect the green jack to the headphone port on the computer.
- 3 Connect the pink jack to the microphone port on the computer.
- 4 Open the computer's sound control panel and set the LS25 to be the input and output device.

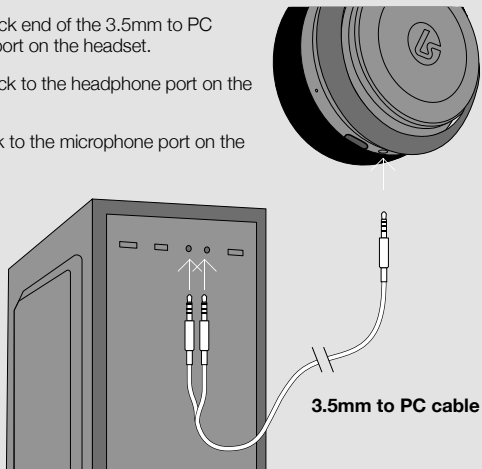

## For computers with a single combined headphone/mic port

- 1 Connect one end of the mobile cable to the 3.5mm port on the headset and the other end to the 3.5mm port on the computer.
- 2 Open the computer's sound control panel and set the LS25 to be the input and output device.

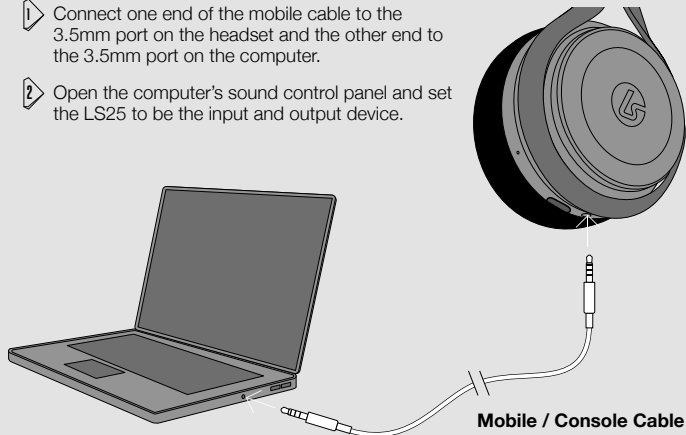

# ENABLING WINDOWS SONIC FOR HEADPHONES [ XBOX ONE | PC ]



EN

## For XBOX ONE

Press the Xbox Guide button and navigate to **All settings > Display & sound > Audio output**. Under the Headset Audio dropdown select 'Windows Sonic for Headphones'.

## For PC

Right click the speaker icon in the taskbar. Choose **Spatial Sound (None)** from the pop up menu. Choose 'Windows Sonic for Headphones' as the Spatial sound format. Click 'OK.'

# SUPPORT

?#!\*

Model No: LS25

LucidSound, Inc.  
Made in China

©2018 Lucid Sound, Inc. 701 Palomar Airport Rd., Suite 230, Carlsbad, CA 92011 U.S.A. LucidSound and the Lucid Sound logo, are trademarks of Lucid Sound, Inc., its subsidiaries, and affiliates. The shape and design of this product are a trade dress of Lucid Sound, Inc., its subsidiaries and affiliates. All rights reserved. All other product names and images are trademarks or registered trademarks of their respective owners. Made in China. Product features, appearance and specifications may be subject to change without notice. Please retain this information for future reference.

A copy of the EU/ED Declaration of Conformity can be found at [lucidsound.com/EUDOC](http://lucidsound.com/EUDOC).

**Warranty**

LucidSound, Inc. warrants this product to be free from defects in materials and workmanship for the warranty period. This non-transferable, 1-year limited warranty is only to you, the first end-user purchaser. If a defect covered by this warranty occurs AND you provide proof of purchase, LucidSound, Inc., at its option, will repair or replace the product at no charge (excluding shipping to LucidSound).

The LucidSound, Inc., 1-year limited warranty is available to customers in the United States and worldwide. Your sole and exclusive remedy is repair or replacement of your LucidSound product. In no event shall LucidSound's liability exceed the original purchase price of the product. This warranty does not apply to: (a) normal wear and tear or abusive use; (b) industrial, professional or commercial use; (c) if the product has been tampered with or modified. This non-transferable warranty is only valid in the region/country in which the headset was originally purchased.

To receive warranty service, please contact us at:

**lucidsound.com**  
**(toll free) 888-661-4469**  
**1-760-579-6969**

**Europe**

LucidSound, Inc. 2-year limited warranty is available to customers in Europe.

**Australia**

Our goods come with guarantees that cannot be excluded under the Australian Consumer Law. You are entitled to a 1 year replacement warranty in which you are entitled to have the goods repaired or replaced if the goods fail to be of acceptable quality and the failure does not amount to a major failure.

What you must do:

If a defect has appeared within 90 days from the date of purchase, the product may be returned to the retailer for a replacement.

If a defect has appeared after 90 day from the date of purchase, you must initiate a repair by following the online repair process at [www.lucidsound.com.au](http://www.lucidsound.com.au).

Once all details are completed, you will receive a return authorisation number.

Then label and ship your LucidSound headset – including the return authorisation (RA) number, freight prepaid, to LucidSound's authorised repair centre.

LucidSound  
c/o Tecworks International Pty Ltd  
Unit 1 / 12 Tollis Place  
Seven Hills NSW 2141

Please ensure the return authorisation (RA) number is prominently displayed on the outside of your packaging. The cost incurred to return the product to the retailer or to the authorised repair centre as part of a Warranty claim are your responsibility.

What we will do:

During the Warranty Period, we will, at our option, repair or replace the product or any defective parts. We will also bear the reasonable costs of standard return shipping. If this cannot be done, then we will refund the purchase price to you.

AU wholesale distributor:

Bluemouth Interactive Pty Ltd, Level 2, 2 Darling Street, South Yarra, Victoria, 3141

Email: [support@bluemouth.com.au](mailto:support@bluemouth.com.au)







[G]

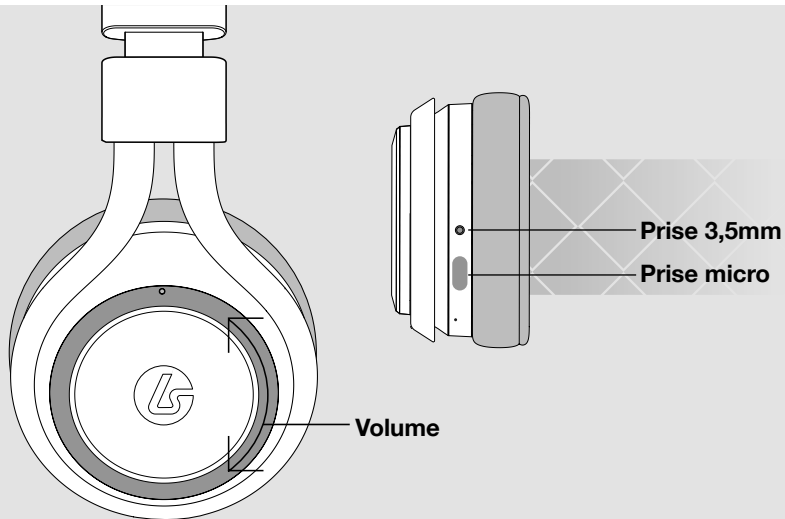

[D]

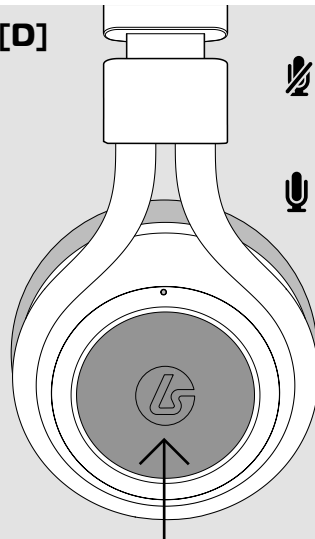

Appuyez pour désactiver le son du micro

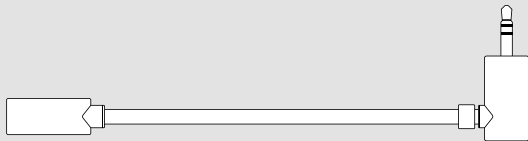
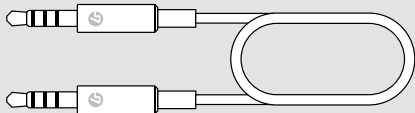
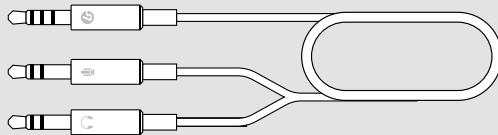
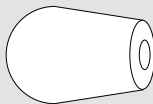

Appuyez à nouveau pour réactiver le son du le micro

**1** Micro externe**2** Câble mobile / console**3** Câble 3,5mm à PC**4** Bonnette anti-vent**5** Couverture du prise micro externe

# MICRO EXTERNE



Le LS25 inclus un micro externe optionnel. Lorsque ce micro n'est pas branché, un micro interne est active.

Pour connecter le micro externe, insérer le simplement dans le port prévu a cet effet sur la partie inferieure du casque.

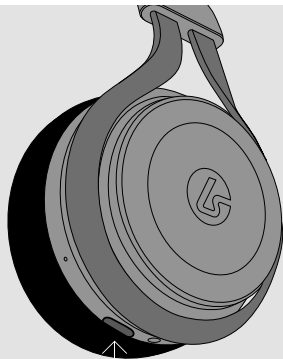

# INSTALLATION PLAYSTATION 4



FR

- 1 Aller dans **reglages > appareils > appareils audio** et régler la sortie vers casque sur «tout audio».
- 2 Régler le «Controlle du volume casque» sur maximum. Vous pouvez maintenant utiliser les controles du casque pour ajuster le volume et le coupure du volume.

# MOBILE



Connecter le câble mobile sur le port 3,5mm du casque et l'autre extrémité sur le port 3,5mm de l'appareil mobile.

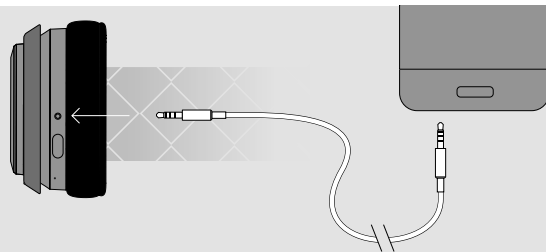

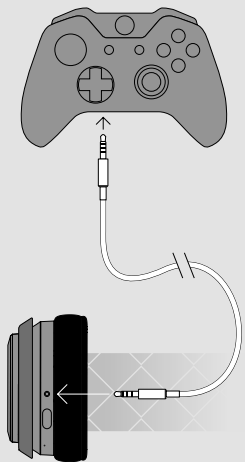

## Manettes avec port 3,5mm

- 1 Connecter le câble chat sur le port 3,5mm du casque et l'autre extrémité sur le port 3,5mm de la manette.
- 2 Appuyez sur le bouton Xbox Guide et naviguez jusqu'à l'icône de l'engrenage. Ensuite, faites défiler vers le bas et sélectionnez «**audio**».
- 3 Mettre le «**volume casque**» au maximum. Assurez-vous que «**micro casque**» est activé.
- 4 Régler le niveau du chat du casque au niveau désiré, 50% est le réglage par défaut. Vous pouvez maintenant utiliser les contrôles du casque pour ajuster le volume et le coupure du volume.

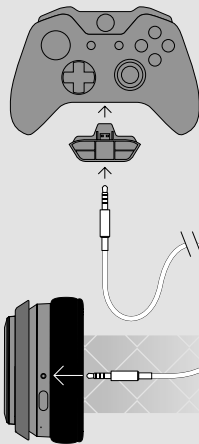

## Manettes sans port 3,5mm

Si la manette ne dispose pas de port 3,5mm, un adaptateur Xbox One pour casque Stereo est requis (non inclus).

- 1 Connecter le câble chat sur le port 3,5mm du casque et l'autre extrémité sur le port 3,5mm de la manette.
- 2 Ajuster la balance jeu/chat sur l'adaptateur stereo au niveau désiré.
- 3 Ajuster le volume de l'adaptateur stereo au maximum. Vous pouvez maintenant utiliser les contrôles du casque pour ajuster le volume et le coupure du volume.



## Pour les ordinateurs avec des ports casque et micro distincts

- 1 Connectez la prise simple sur une extrémité du câble de 3,5 mm au PC au port 3,5 mm du casque.
- 2 Connectez la prise verte au port du casque sur l'ordinateur.
- 3 Connectez la prise rose au port du microphone sur l'ordinateur.
- 4 Ouvrez le panneau de contrôle du son de l'ordinateur et configurez le LS25 comme étant périphérique d'entrée et de sortie.

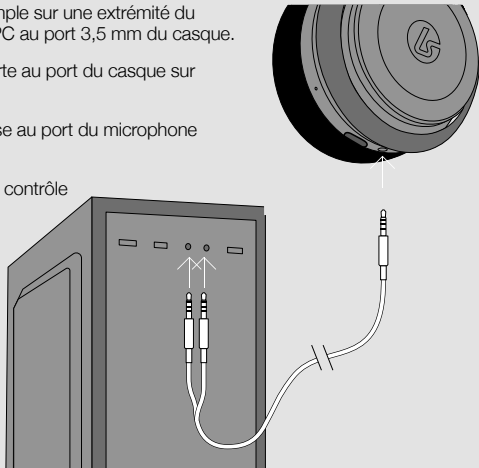

## Pour ordinateurs équipés d'un seul combiné casque / microphone

- 1 Connectez une extrémité du câble mobile au port 3,5 mm du casque et l'autre extrémité au port de 3,5 mm sur l'ordinateur.
- 2 Ouvrez le panneau de contrôle du son de l'ordinateur et configurez le LS25 comme étant le périphérique d'entrée et de sortie.



FR

# ACTIVATION DE WINDOWS SONIC FOR HEADPHONES [ XBOX ONE | PC ]



## Pour XBOX ONE

Appuyez sur le bouton Xbox Guide et naviguez à **Reglages > Image et son > Sortie Audio**. Dans la liste déroulante «**Casque Audio**», sélectionnez «**Windows Sonic for Headphone**».

## Pour PC

Cliquez avec le bouton droit de la souris sur l'icône du haut-parleur dans la barre des tâches. Choisissez **le son de Spatial (None)** dans le menu contextuel. Choisissez «**Windows Sonic for Headphones**» en tant que format de son spatial. Cliquez sur 'OK'.

# SUPPORT

?#!\*

**Model No:** LS25  
Fabriqué en Chine

©2018 Lucid Sound, Inc.

Lucid Sound Inc garantit ce produit contre tout défaut de matériau ou de fabrication durant la période de garantie. Cette garantie limitée non transférable de 2 ans (Canada: garantie limitée non transférable de 1 an) n'est valable que pour le premier acheteur du produit. Si un défaut couvert par cette garantie survient ET si vous avez la preuve d'achat du produit, Lucid Sound Inc, procèdera, a sa discrétion, au remplacement ou à la réparation du produit à sa charge (excepte les frais d'envoi à Lucid Sound). Cette garantie non transférable n'est valable que dans la région / le pays dans lequel le casque a été acheté à l'origine.

La garantie limitée de 2 ans offerte par Lucid Sound Inc, est valable pour les clients Européens. Le seul et unique remède est la réparation ou le remplacement de votre produit Lucid Sound. En aucun cas la responsabilité de Lucid Sound ne pourra excéder le montant initial d'achat du produit. Cette garantie ne s'applique pas à : (a) Usure normale due à l'utilisation ou utilisation abusive ; (b) usage industriel, professionnel ou commercial ; (c) Si le produit a été modifié ou démonté.

Pour recevoir le service de garantie s'il vous plaît nous contacter à : [lucidsound.com](http://lucidsound.com)

Un exemplaire de la Déclaration de Conformité CE/UE peut être trouvé à [lucidsound.com/EUDOC](http://lucidsound.com/EUDOC).

# HEADSET



DE

[L]

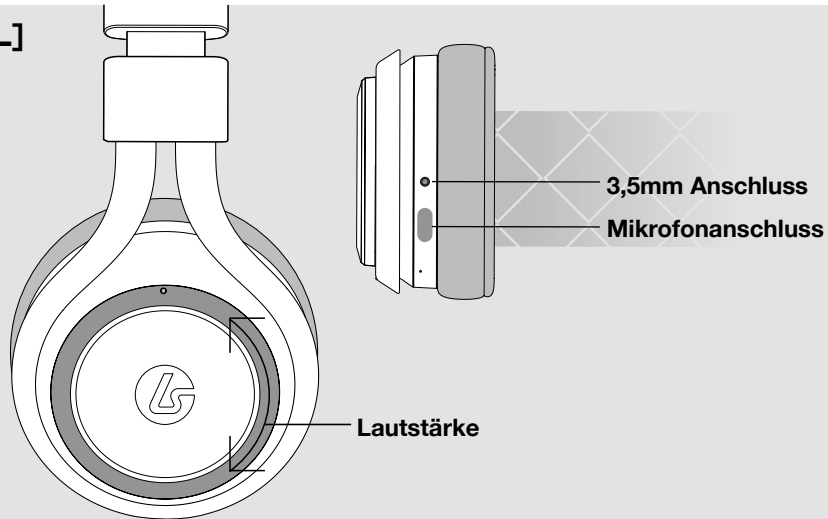

[R]

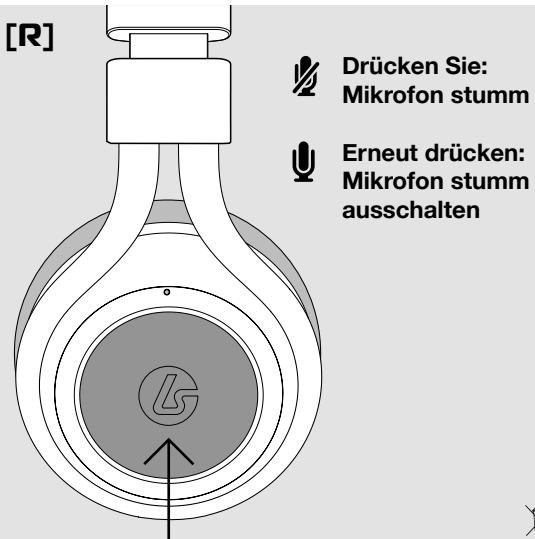

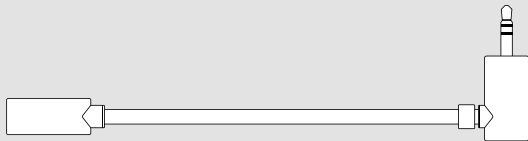
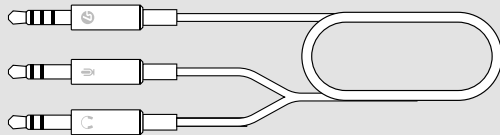
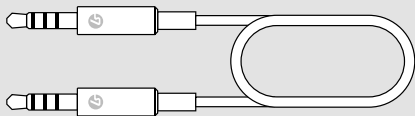
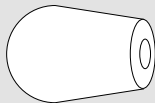
**1** Mikrofonarm**3** 3,5mm zum PC-Kabel**2** Kabel für Mobil / Konsole**4** Mikrofon-Windschutz**5** Mikrofonanschluss Kappe



# MIKROFON



Das LS25 wird mit einem optionalen Mikrofonarm geliefert. Wenn dieses Mikrofon entfernt wird, dann wird automatisch ein internes Mikrofon aktiviert.

Um den Mikrofonarm mit dem Headset zu verbinden, muss es einfach in den entsprechenden Anschluss an der Unterseite des Headsets gesteckt werden.

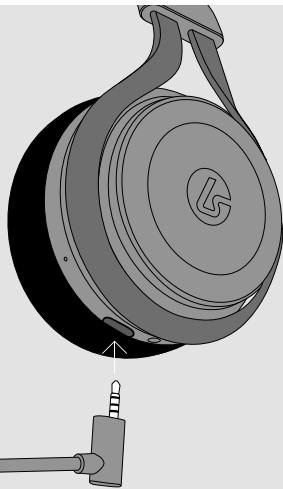

# PLAYSTATION 4 SETUP



DE

- 1 Gehen sie in **Einstellungen -Geräte - Audiogeräte** und stellen sie den Ausgang zum Kopfhörer auf "Gesamtes Audio".
- 2 Stellen Sie die Lautstärkeregelung (Kopfhörer) auf Maximum ein.Sie können nun die Bedienelemente am Headset verwenden, um die Lautstärke einzustellen und stumm zu schalten.

# MOBILE SETUP



Verbinde das eine Ende des Mobilgerätekabels mit dem 3,5mm Anschluss am Headset und das andere Ende des Kabels mit dem 3,5mm Ausgang am Mobilgerät.

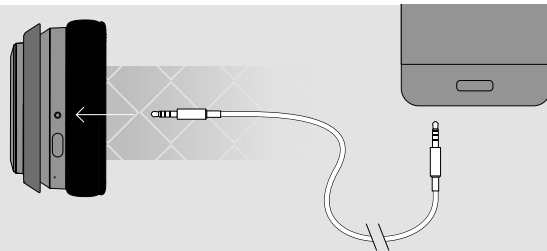

## Mit 3,5mm Anschluß

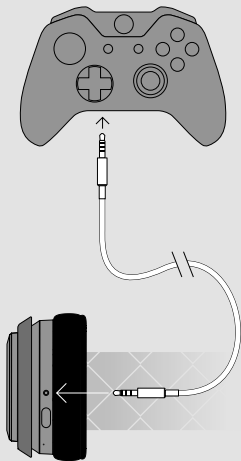

- 1 Stecke das eine Ende des Xbox One Chatkabels in den 3,5mm Anschluss am Headset und das andere Ende in den 3,5mm Anschluss des Controllers
- 2 Drücken Sie die Taste Xbox Guide und Navigiere zum Gang-Symbol. Scrollen Sie dann nach unten und wählen Sie **"Audio"**.
- 3 Setze **"Headset Lautstärke"** auf maximum. Versichern Sie sich, dass das Headset Mikrofon eingeschaltet ist.
- 4 Stellen sie den **"Headset Chat Mixer"** auf das gewünschte Niveau von Chat- und Spielaudio Balance (Standard ist 50%). Sie können nun die Bedienelemente am Headset verwenden, um die Lautstärke einzustellen und stumm zu schalten.

## Ohne 3,5mm Anschluß

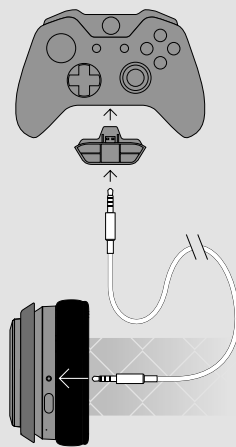

Wenn der Xbox One Controller nicht über einen 3,5mm Anschluss verfügt, wird der Xbox One Stereo Headset Adapter benötigt. (nicht beinhaltet).

- 1 Stecke das eine Ende des Xbox One Chatkabels in den 3,5mm Anschluss am Headset und das andere Ende in den 3,5mm Anschluss des Stereo Headset Adapter .
- 2 Justieren sie die Game / Chat Balance am Stereo Headset Adapter auf das gewünschte Niveau von Chat und Spielaudio Balance.
- 3 Stellen sie die Lautstärke am Stereo Headset Adapter auf Maximum. Sie können nun die Bedienelemente des Headsets verwenden, um die Lautstärke einzustellen und stumm zu schalten.



## Für Computer mit separaten Kopfhörern und Mikrofonanschlüssen

- 1 Verbinden Sie die einzelne Buchse am Ende des 3,5-mm-PC-Kabels mit dem 3,5-mm-Anschluss am Headset.
- 2 Verbinden Sie die grüne Buchse mit dem Kopfhöreranschluss am Computer.
- 3 Verbinden Sie die rosa Buchse mit dem Mikrofonanschluss am Computer.
- 4 Öffnen Sie das Sound-Bedienfeld des Computers und stellen Sie das LS25 als Eingabe- und Ausgabegerät ein.

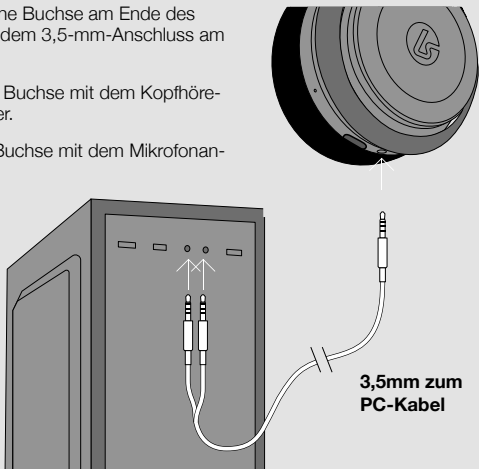

## Für Computer mit einem einzigen kombinierten Kopfhörer / Mikrofonanschluss

- 1 Verbinden Sie ein Ende des Mobilkabels mit dem 3,5-mm-Port am Headset und das andere Ende mit dem 3,5-mm-Port am Computer.
- 2 Öffnen Sie das Sound-Bedienfeld des Computers und stellen Sie das LS25 als Eingabe- und Ausgabegerät ein.



# DE

# AKTIVIEREN VON WINDOWS SONIC FOR HEADPHONES [ XBOX ONE | PC ]



## FÜR XBOX ONE

Drücken Sie die Xbox Guide-Taste und navigieren Sie zu **Alle Einstellungen > Display & Sound > Audio-Ausgang**. Wählen Sie unter dem Headset Audio Dropdown 'Windows Sonic for Headphones' aus

## FÜR PC

Klicken Sie mit der rechten Maustaste auf das Lautsprechersymbol in der Taskleiste. Wählen Sie **Spatial Sound (None)** aus dem Popup-Menü. Wählen Sie **"Windows Sonic for Headphones"** als das räumliche Klangformat. "OK" klicken.

# SUPPORT



Model No: LS25

©2018 LucidSound, Inc.

Lucid Sound, Inc. garantiert, dass dieses Produkt frei von Mängeln in Material und Verarbeitung für den Garantiezeitraum ist. Diese nicht übertragbare, 2 Jahre Garantie (Canada: 1 Jahre Garantie) ist nur für Sie, den ersten Käufer und Endbenutzer. Soweit ein Mangel, der von dieser Garantie gedeckt wird, auftritt und Sie über einen Nachweis über den Kauf des Produkt verfügen, wird Lucid Sound, Inc. nach eigenem Ermessen entweder reparieren oder das Produkt kostenlos (ohne Versandkosten zu Lucid Sound) ersetzen. Diese nicht übertragbare Garantie gilt nur in der Region / Land, in der das Headset ursprünglich gekauft wurde.

Die Lucid Sound, Inc. 2 Jahre Garantie ist für Kunden in Europe verfügbar. Die einzige und ausschließliche Abhilfe ist Reparatur oder der Ersatz Ihres Lucid Sound Produkts. In keinem Fall überschreitet die Haftung von Lucid Sound, Inc. den ursprünglichen Kaufpreis des Produkts. Diese Garantie gilt nicht für: (a) normalen Verschleiß oder Missbrauch; (b) Industrie, berufliche oder kommerzielle Zwecke; (c) wenn das Produkt manipuliert oder verändert wurde.

Um Garantieservice zu erhalten kontaktieren Sie uns bitte wie folgt: [lucidsound.com](http://lucidsound.com)

Eine Kopie der EU/EG-Konformitätserklärung finden sie unter [lucidsound.com/EUDOC](http://lucidsound.com/EUDOC).



[S]

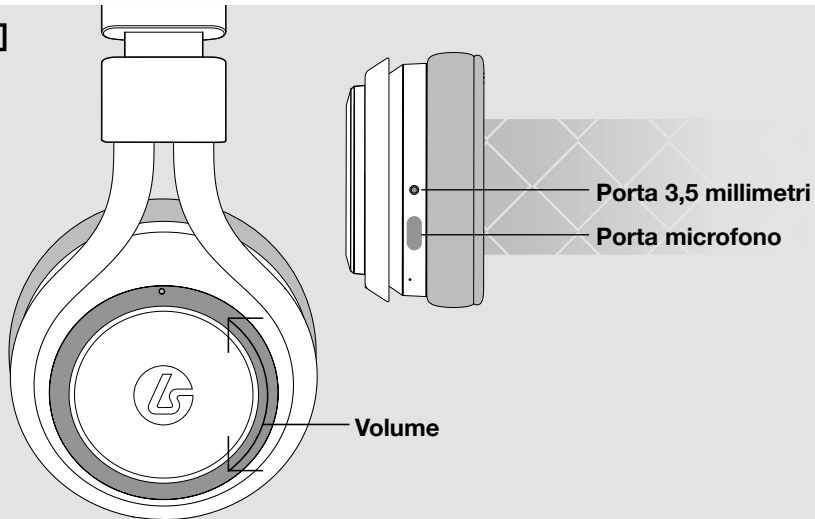

[D]



Premere per  
silenziare il  
microfono



Premere nuova-  
mente per riatti-  
vare il microfono



**1** Microfono a braccio

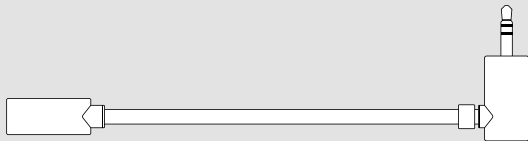

**2** Cavo per dispositivo mobile / console

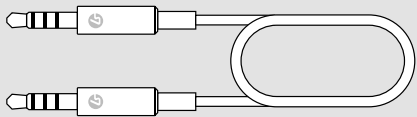

**3** Cavo 3,5 millimetri a PC

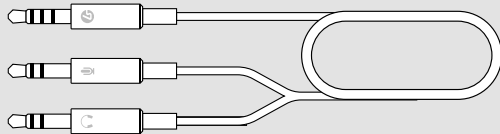

**4** Protezione anti-vento

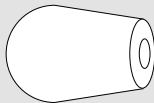

**5** Coperchio della porta Mic



# MICROFONO



L'LS25 include un microfono ad asta opzionale. Quando questo microfono viene rimosso, un microfono interno è attivato.

Per collegare il microfono ad asta, è sufficiente inserirlo nella porta sulla parte inferiore della cuffia.

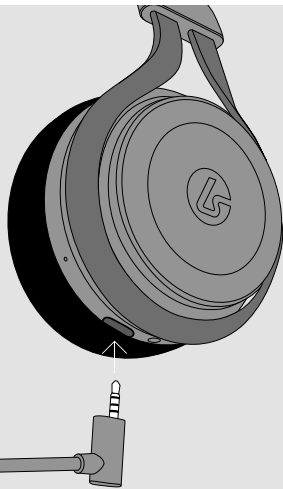

# CONFIGURAZIONE PLAYSTATION 4



IT

- 1 Andate in **Impostazioni > Dispositivi > dispositivi audio** Impostare l'uscita per cuffie per 'All Audio'
- 2 Impostare il 'controllo del volume (cuffie)' al massimo. È ora possibile utilizzare i controlli sull'auricolare per regolare il volume e disattivare la funzione.

# CONFIGURAZIONE CELLULARE



Collegare un'estremità del cavo cellulare all'ingresso 3,5mm Dell'auricolare e l'altra estremità all'uscita 3,5mm del dispositivo mobile.

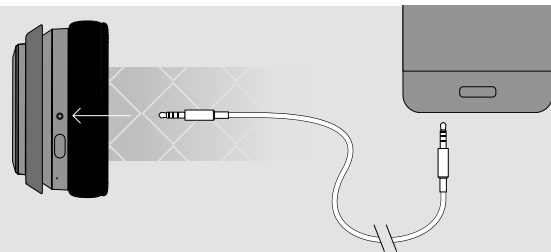

## Con porta 3,5mm

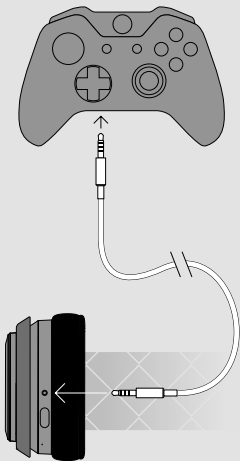

- 1 Collegare un'estremità del cavo chat Xbox One alla porta 3,5 millimetri dell'auricolare e l'altra estremità alla porta 3,5mm sul controller.
- 2 Premere il pulsante Guida Xbox e Spostarsi sull'icona a forma di ingranaggio. Quindi, scorrere verso il basso e selezionare **'Audio'**.
- 3 Selezionare **'Volume'** e impostare **'il volume Auricolare'** a massimo. Assicurarsi che 'auricolare microfono' è rivolto a 'On'.
- 4 Impostare 'mixer auricolare chat' per il livello desiderato di chat ed gioco audio bilanciato (di default è 50%). È ora possibile utilizzare il controllo del volume sulla rotella per regolare il volume e disattivare il microfono.

## Senza porta 3,5mm

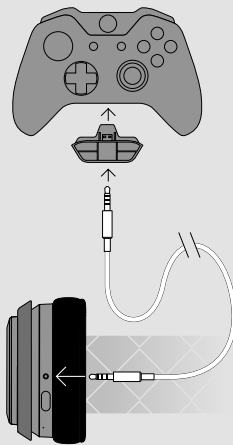

Si la manette ne dispose pas de port 3,5mm, un adaptateur Xbox One pour casque Stereo est requis (non inclus).

- 1 Collegare un'estremità del cavo chat alla porta 3,5 mm dell'auricolare e l'altra estremità alla porta 3,5mm dell'adattatore Auricolare Stereo.
- 2 Regolare il volume sul Adattatore auricolare stereo su Massimo. È ora possibile utilizzare il controllo del volume sulla rotella di sinistra per regolare il volume.
- 3 Impostare il 'controllo del volume (cuffie)' al massimo. È ora possibile utilizzare il controllo del volume sulla rotella di sinistra per regolare il volume.





## Per i computer con cuffie separate e porte microfono

- 1 Collegare l'estremità singola jack del cavo da 3,5 mm a PC alla porta da 3,5 mm sull'auricolare.
- 2 Collegare il jack verde alla porta cuffie del computer.
- 3 Collegare il jack rosa alla porta del microfono del computer.
- 4 Aprire il pannello di controllo del suono del computer e impostare LS25 come dispositivo di input e output.

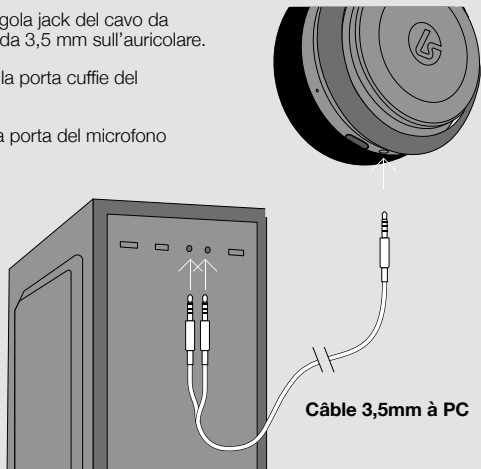

## Per i computer con una singola cuffia / microfono combinato

- 1 Collegare un'estremità del cavo mobile alla porta da 3,5 mm sull'auricolare e l'altra estremità alla porta da 3,5 mm sul computer.
- 2 Aprire il pannello di controllo del suono del computer e impostare LS25 come dispositivo di input e output.

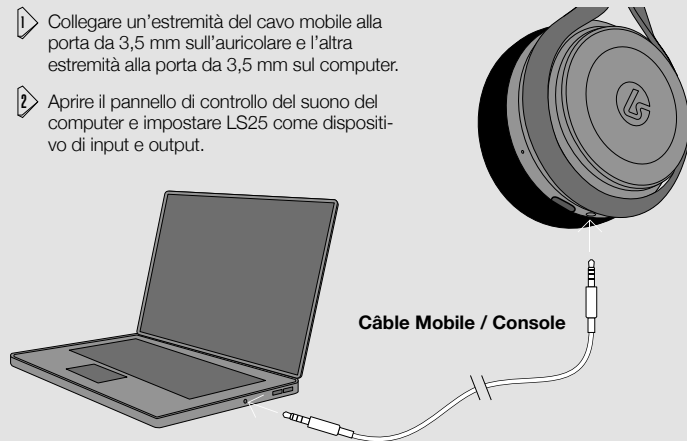

# IT

# ABILITANDO WINDOWS SONIC FOR HEADPHONES [ XBOX ONE | PC ]



## Per XBOX ONE

Premere il pulsante Guida Xbox e passare a **Tutte le impostazioni**> **Display e audio**> **Uscita audio**. Sotto il menu a discesa Audio auricolare selezionare **'Windows Sonic per le cuffie'**.

## Per PC

Fare clic con il pulsante destro del mouse sull'icona dell'altoparlante nella barra delle applicazioni. Scegli il **carattere Spatial (Nessuno)** dal menu a comparsa. Scegliere **"Windows Sonic per le cuffie"** come formato audio spaziale. Fai clic su "OK".

# SUPPORTO

# ?#!\*

Model No: LS25

©2018 Lucid Sound, Inc.

Lucid Sound, Inc. garantisce che questo prodotto è privo di difetti in materiali e manodopera per il periodo di garanzia. Questa garanzia limitata, non trasferibili, di 2 anni (Canada: 1 anno) è solo per voi, il primo utente finale acquirente. Se un difetto coperto da questa garanzia si verifica E potete fornire la ricevuta di acquisto, Lucid Sound, Inc., a sua discrezione, riparerà o sostituirà il prodotto gratuitamente (escluso il trasporto a Lucid Sound). Questa garanzia non trasferibile è valida solo nella regione / paese in cui l'auricolare è stato originariamente acquistato.

Lucid Sound, Inc., garanzia limitata di 2 anni di è disponibile per i clienti europei. L'unico ed esclusivo rimedio è la riparazione o la sostituzione del prodotto Lucid Sound. In nessun caso la responsabilità di Lucid Sound può essere superiore al prezzo di acquisto originale del prodotto. Questa garanzia non si applica a: (a) normale usura o uso abusivo; (b), l'uso professionale, commerciale o industriale; (c) se il prodotto è stato manomesso o modificato.

Per ricevere assistenza in garanzia, vi preghiamo di contattarci all'indirizzo: [lucidsound.com](http://lucidsound.com)

Una copia della dichiarazione UE/CE di Conformità è disponibile all'indirizzo [lucidsound.com/EUDOC](http://lucidsound.com/EUDOC).



## INFORMAZIONE AGLI UTENTI DI APPARECCHIATURE DOMESTICHE

Ai sensi dell'art. 26 del Decreto Legislativo 14 marzo 2014, n. 49 "Attuazione della Direttiva 2012/19/UE sui Rifiuti di Apparecchiature Elettriche ed Elettroniche (RAEE)" e del Decreto Legislativo 188 del 20 novembre 2008.

Il simbolo del cassonetto barrato riportato sull'apparecchiatura o sulla sua confezione indica che il prodotto alla fine della propria vita utile deve essere raccolto separatamente dagli altri rifiuti per permetterne un adeguato trattamento e riciclo.

Si ricorda che le pile/accumulatori eventualmente presenti, laddove possibile, debbono essere rimosse dall'apparecchiatura prima che questa sia conferita come rifiuto.

L'utente potrà, pertanto, conferire gratuitamente l'apparecchiatura e l'eventuale batteria giunta a fine vita agli idonei centri comunali di raccolta differenziata dei rifiuti elettrici ed elettronici. In alternativa l'utente potrà riconsegnarle al rivenditore secondo le seguenti modalità:

- sia pile portatili sia apparecchiature di piccole dimensioni, ovvero con almeno un lato esterno non superiore a 25 cm, è prevista la consegna gratuita senza obbligo di acquisto presso i negozi con una superficie di vendita delle apparecchiature elettriche ed elettroniche superiore ai 400 mq. Per negozi con dimensioni inferiori, tale modalità è facoltativa.
- per apparecchiature con dimensioni superiori a 25 cm, è prevista la consegna in tutti i punti di vendita in modalità 1 contro 1, ovvero la consegna al rivenditore potrà avvenire solo all'atto dell'acquisto di un nuovo prodotto equivalente, in ragione di uno a uno.

L'adeguata raccolta differenziata per l'avvio successivo dell'apparecchiatura e delle pile/accumulatori dismessi al riciclaggio, al trattamento e allo smaltimento ambientalmente compatibile contribuisce ad evitare possibili effetti negativi sull'ambiente e sulla salute e favorisce il reimpiego e/o riciclo dei materiali di cui essi sono composti.

Lo smaltimento abusivo di apparecchiature, pile ed accumulatori da parte dell'utente comporta l'applicazione delle sanzioni di cui alla corrente normativa di legge.

ES

# AURICULAR



[I]

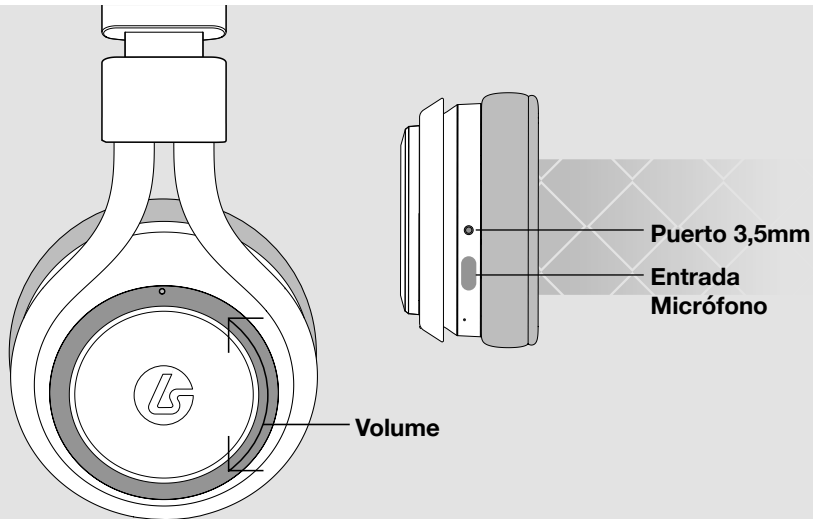

[D]





**1** Brazo de micro

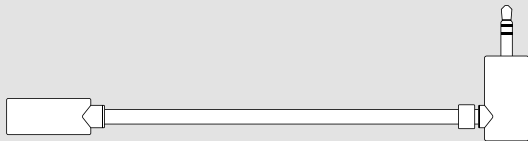

**3** Cable de 3,5 mm a PC

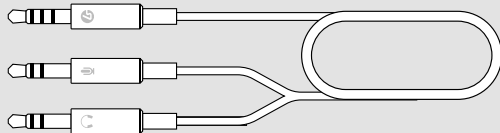

**2** Cable para dispositivo móvil / consola

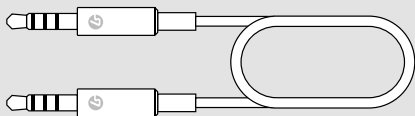

**4** Quitaviento micrófono

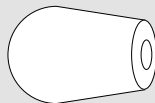

**5** Puerto de micro cubierto



# ES

## MICRÓFONO



El LS25 incluye un micrófono opcional. Cuando el brazo del micro se desistala, un micrófono interno se activa.

Para conectar el micrófono, es muy sencillo, inserta el brazo del micro en el puerto del auricular.

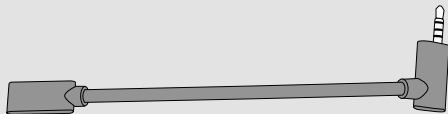
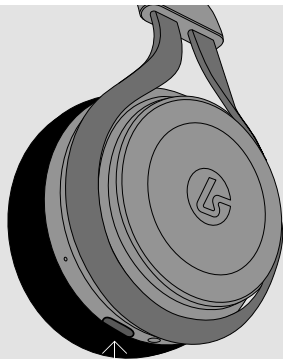

## CONFIGURACIÓN PLAYSTATION 4



- 1 Ves a **Ajustes > Dispositivos > Dispositivos** de audio y ajusta la salida de todo el audio del Auricular.
- 2 Ajusta "Control de Volumen (Auricular)" al máximo. Podrás controlar las funciones en el altavoz izquierdo.

## CONFIGURACIÓN MOBILE



Conecta el jack 3.5 mm en la salida del auricular, y el otro extremo en la salida de audio del dispositivo móvil.

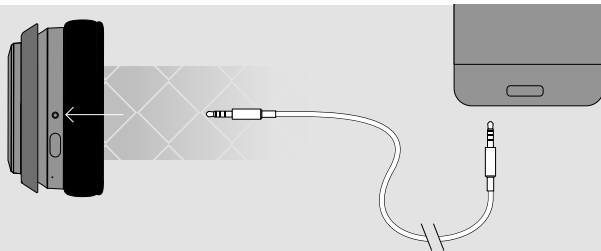

## Con conexión en el puerto 3.5mm del Mando

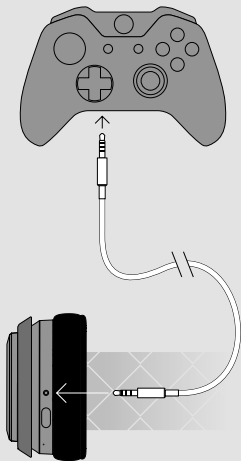

- 1 En la Xbox One conecta el cable Jack 3.5 mm en el puerto del auricular, el otro extremo en el puerto 3.5 mm del Mando.
- 2 Presione el botón Guía Xbox y navegue hasta el icono de engranaje. Luego, desplácese hacia abajo y seleccione 'Audio'.
- 3 Selecciona Volumen y establece el Volumen Auricular al máximo y el control del micrófono al mínimo. Asegúrese de que 'micrófono auricular está activada.
- 4 Ajuste "Auricular chat mixer" para el los niveles de chat y el balance del audio del juego (por defecto el 50%). Ahora puede utilizar los controles de los auriculares para ajustar el volumen y mute.

## Cuando se utiliza un adaptador de auriculares estéreo

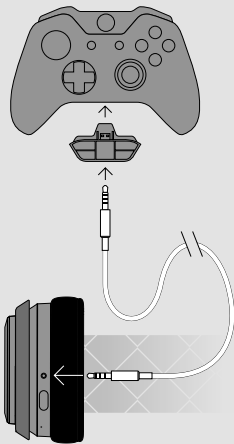

**En el caso de que tú mando de la Xbox One no incluya el puerto para la conexión del auricular estéreo. Es necesario el adaptador correspondiente (no incluido).**

- 1 En tu Xbox One conecta el cable Jack 3.5 mm en el puerto del auricular, el otro extremo en el puerto 3.5 mm del adaptador para el auricular estéreo.
- 2 Ajustar los niveles de audio del juego/ chat en el auricular estéreo. Adaptador para el los volúmenes personalizados.
- 3 Ajustar el volumen del auricular estéreo hasta para maximizar. Ahora puede utilizar los controles de los auriculares para ajustar el volumen y mute.

## Para equipos con auriculares y puertos de micrófono independiente

- 1 Conecte el extremo del conector del cable de 3,5 mm a 3,5 mm PC al puerto de los auriculares.
- 2 Conecte la toma verde al puerto de auriculares del equipo.
- 3 Conecte el conector de micrófono de color rosa al puerto en el equipo.
- 4 Abra panel de control de sonido del ordenador y en septiembre la LS25 para ser el dispositivo de entrada y de salida.

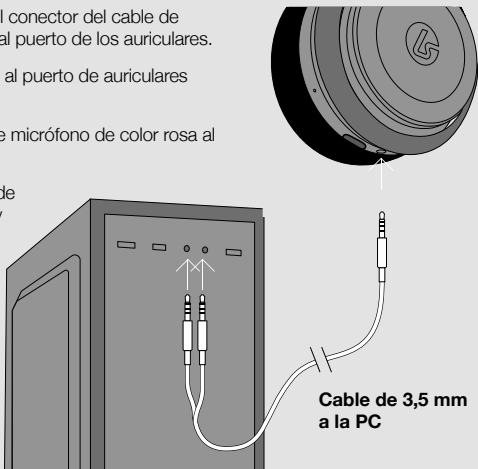

## Para equipos con un puerto de salida de auriculares / micrófono combinado

- 1 Conecte un extremo del cable flotante en el puerto de 3.5mm en el auricular y el otro extremo al puerto de 3,5 mm en el equipo.
- 2 Abra panel de control de sonido del ordenador y en septiembre la LS25 para ser el dispositivo de entrada y de salida.





# ACTIVACIÓN DE WINDOWS SONIC FOR HEADPHONES [ XBOX ONE | PC ]



ES

## Para XBOX ONE

Presione el botón Guía Xbox y vaya a **todos los ajustes > Sonido y pantalla > Salida de audio**. Bajo el menú desplegable de auriculares de audio seleccione 'de Windows para Sonic Auriculares'.

## Para PC

Haga clic en el icono del altavoz en la barra de tareas. Elija **Spatial de sonido (Ninguno)** en el menú emergente. Elija 'de Windows para Sonic Auriculares' como el formato de sonido espacial. Haga clic en 'Aceptar'.

## SOPORTE

?#!\*

Model No: LS25

©2018 Lucid Sound, Inc.

Lucid Sound, Inc. garantiza los materiales y mano de obra durante el periodo de garantía del producto. Esto no es transferible, la garantía tiene una limitación de 2 años (Canada: 1 año). Importante! sólo podrá ser utilizada por el al usuario final. Cualquier defecto será cubierto bajo esta garantía. Es necesario presentar el comprobante de compra. Lucid Sound, Inc., reparará o reemplazará el producto sin cargos (Como excepción la compañía no se hará cargo del coste del envío en tu dirección del auricular Lucid Sound). Esta garantía intransferible solo es válida en la región / país en el que se adquirió originalmente el auricular.

La garantía limitada de 2 años será para los clientes europeos. Su único, y exclusivo derecho es la reparación o sustitución de su producto Lucid Sound. En ningún caso la responsabilidad de auricular Lucid Sound excederá del precio de compra original del producto. Esta garantía no se aplica a : ( a) el desgaste normal o el uso abusivo ; ( b) el uso industrial , comercial o profesional ; ( c) si el producto ha sido manipulado o modificado previamente.

Para recibir la garantía, por favor contacte con nosotros en: [lucidsound.com](http://lucidsound.com)

La Declaración de Conformidad de la UE/CE se puede consultar en [lucidsound.com/EUDOC](http://lucidsound.com/EUDOC).

