

*wireless - sans fil*

# LS31

GAMING HEADSET  
CASQUE DE JEU



USER GUIDE  
GUIDE D'UTILISATION  
BEDIENUNGSANLEITUNG  
GUÍA DE USO  
MANUALE D'USO





[L]



**Game Mute Button**

**Game Volume Wheel**

## Power/Charging LED

Solid = ON/Connected/Charged

Slow Blink = Not Connected

Fast Blink = Battery Low

Pulsing = Charging

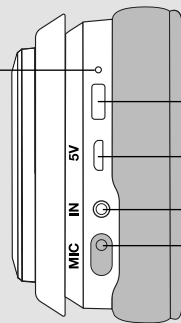

**Power Button**

**USB Charging Port**

**Mobile/Xbox Chat Port**

**Microphone Port**

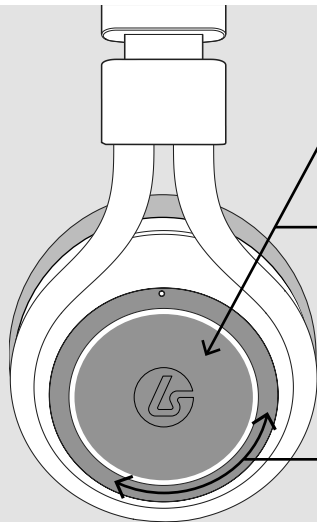

[R]

**Mic Monitoring**

Mic Monitor On/Off = Press and hold  
for 3 seconds

**Mic Mute**

Mute/Unmute = Short Press

LED on Boom Mic  
illuminates when muted

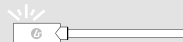
**Chat Volume  
Wheel****EQ Select**

- 1 beep = Normal
- 2 beeps = Bass Boost
- 3 beeps = Treble Boost

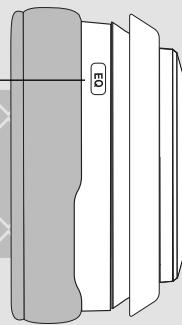

# ACCESSORIES



# BASE STATION

EN

## 1 Boom Mic

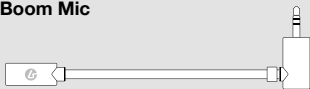

## 3 USB Charging Cable

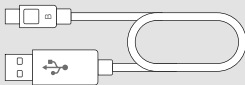

## 5 Mic Port Cover



## 2 Optical Cable

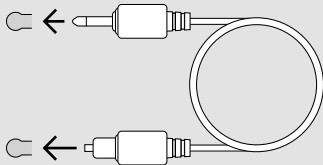

## 4 Xbox Chat Cable / Mobile 3.5mm Cable

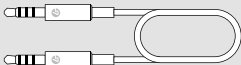

### Status LED

Solid = Connected  
Flashing = Not Connected

### Optical Input

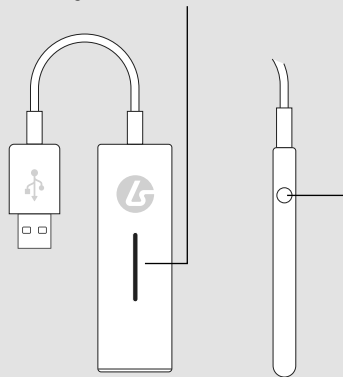

# EN

## CHARGING



Pulsing = Charging  
Solid = Charged

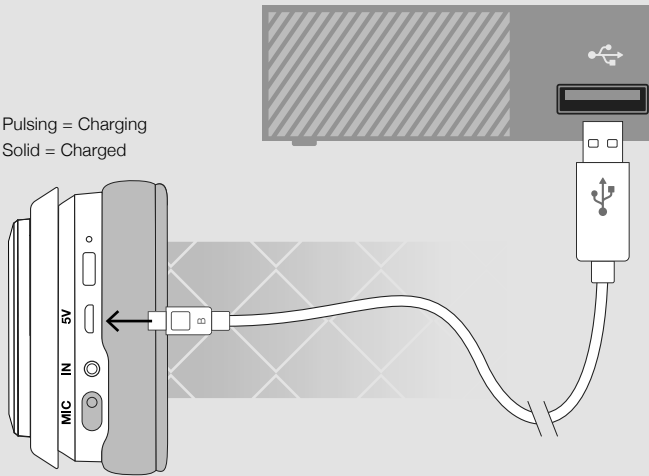

## MICROPHONE

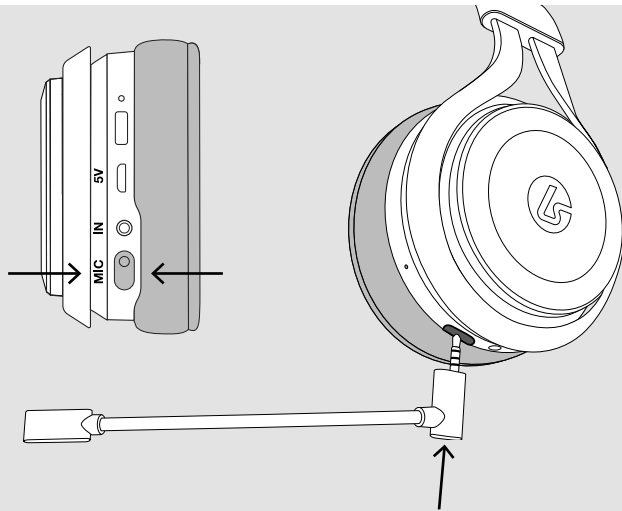

## PS4 and PS4 PRO

**!!! IMPORTANT !!!**

To complete setup for PS4 (original) and PS4 Pro, go to:



<https://bit.ly/2tuC3FW>

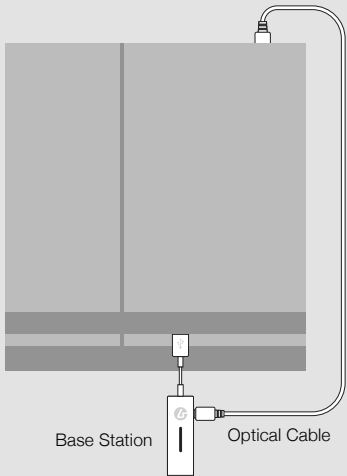

## PS4 Slim

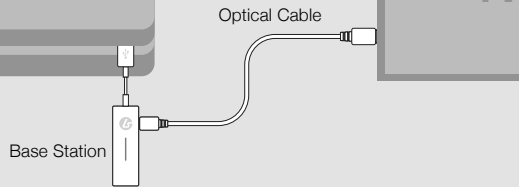

**!!! IMPORTANT !!!**

To complete setup for PS4 Slim, go to:

<https://bit.ly/2KpZMla>



EN

# XBOX ONE SETUP

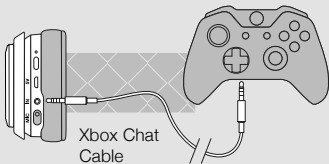
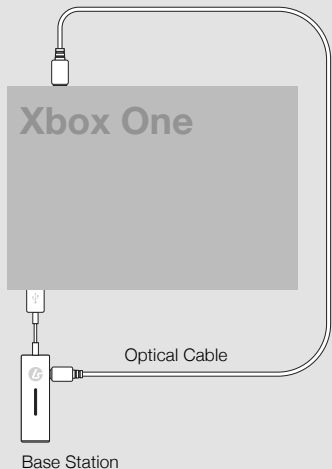

**!!! IMPORTANT !!!**

To complete setup for  
Xbox One, go to:



<https://bit.ly/2lDe5or>

# PC / MAC SETUP



**!!! IMPORTANT !!!**

For detailed setup instructions  
for PC/Mac, go to:

<https://bit.ly/2KnD7pp>



# MOBILE SETUP



With the headset powered OFF, connect the Mobile 3.5mm cable between the headset and the phone. The volume and mute controls do not function in this mode.

**Model No:** LS31RX  
**Model No:** LS31TX

**IC:** 21203-06302  
**IC:** 21203-06301

**LucidSound, Inc.**  
Made in China

RF Frequency: 2.40335 GHz to 2.47935 GHz  
Output Power: TX = 5.83 dBm RX = 3.58 dBm  
Manufacturer: LucidSound, Inc.  
Importer: Information can be found at [lucidsound.com](http://lucidsound.com)

This device complies with Industry Canada licence-exempt RSS-247 standard. Operation is subject to the following two conditions: (1) this device may not cause interference, and (2) this device must accept any interference, including interference that may cause undesired operation of the device.

#### IC Radiation Exposure Statement:

This equipment complies with IC RSS-102 radiation exposure limits set forth for an uncontrolled environment. This equipment should be installed and operated with minimum distance 0.5 cm between the radiator and your body.

#### EU DECLARATION OF CONFORMITY



Hereby we guarantee that snakebyte distribution GmbH, located at 13 Konrad-Zuse-Str., Schwerte 58239, Germany, is marketing this device LS31 under the brand name LucidSound and complies with the legal requirements and the requirements of Directive 2014/53/EU. This notification is listed under:

[lucidsound.com/EUDOC](http://lucidsound.com/EUDOC).



#### WEEE (Waste Electrical and Electronic Equipment Directive)

If you eventually want to dispose of this product at a later time, please observe the following instructions: Electronic equipment should not be disposed of together with household waste. Please recycle the device if the appropriate recycling ways are available to you. Please contact your local authority or retailer and ask them for advice on recycling.

#### RoHS

This product has been certified as RoHS compliant in accordance with Directive 2011/65/CE.

#### Disposal of Batteries/Rechargeable Batteries

Please follow regional guidelines for the disposal of rechargeable batteries or contact local authorities, your household waste disposal service or the shop where you purchased the product. Batteries/rechargeable batteries must not be disposed of into the normal household garbage. Please use a rechargeable battery disposal in your neighborhood or community, if available.



#### Warranty

LucidSound, Inc. warrants this product to be free from defects in materials and workmanship for the warranty period. This non-transferable, 1-year limited warranty is only to you, the first end-user purchaser. If a defect covered by this warranty occurs AND you provide proof of purchase, LucidSound, Inc., at its option, will repair or replace the product at no charge (excluding shipping to LucidSound).

The LucidSound, Inc., 1-year limited warranty is available to customers in the United States and worldwide. Your sole and exclusive remedy is repair or replacement of your LucidSound product. In no event shall LucidSound's liability exceed the original purchase price of the product. This warranty does not apply to: (a) normal wear and tear or abusive use; (b) industrial, professional or commercial use; (c) if the product has been tampered with or modified. This non-transferable warranty is only valid in the region/country in which the headset was originally purchased.



To receive warranty service, please contact us at:

**lucidsound.com**  
**(toll free) 888-661-4469**  
**1-760-579-6969**

#### Europe

LucidSound, Inc. 2-year limited warranty is available to customers in Europe.

#### Australia

Our goods come with guarantees that cannot be excluded under the Australian Consumer Law. You are entitled to a 1 year replacement warranty in which you are entitled to have the goods repaired or replaced if the goods fail to be of acceptable quality and the failure does not amount to a major failure.

What you must do:

If a defect has appeared within 90 days from the date of purchase, the product may be returned to the retailer for a replacement.

If a defect has appeared after 90 days from the date of purchase, you must initiate a repair by following the online repair process at [www.lucidsound.com.au](http://www.lucidsound.com.au).

Once all details are completed, you will receive a return authorisation number. Then, label and ship your LucidSound headset – including the return authorisation (RA) number, freight prepaid, to LucidSound's authorised repair centre.

LucidSound  
c/o Tecworks International Pty Ltd  
Unit 1 / 12 Tollis Place  
Seven Hills NSW 2141

Please ensure the return authorisation (RA) number is prominently displayed on the outside of your packaging. The cost incurred to return the product to the retailer or to the authorised repair centre as part of a Warranty claim are your responsibility.

What we will do:

During the Warranty Period, we will, at our option, repair or replace the product or any defective parts. We will also bear the reasonable costs of standard return shipping. If this cannot be done, then we will refund the purchase price to you.

AU wholesale distributor:

Bluemouth Interactive Pty Ltd, Level 2, 2 Darling Street, South Yarra, Victoria, 3141  
**Email: [support@bluemouth.com.au](mailto:support@bluemouth.com.au)**

©2018 Lucid Sound, Inc. 701 Palomar Airport Rd., Suite 230, Carlsbad, CA 92011 U.S.A.  
Lucid Sound and the Lucid Sound logo are trademarks of Lucid Sound, Inc., its subsidiaries, and affiliates. The shape and design of this product are a trade dress of Lucid Sound, Inc., its subsidiaries and affiliates. All rights reserved. All other product names and images are trademarks or registered trademarks of their respective owners. Made in China. Product features, appearance and specifications may be subject to change without notice. Please retain this information for future reference.



[G]



Coupure du son du jeu

Volume du jeu

## Diode Alimentation

- allumé = allumé/connecté/chargée
- clignotement lent = pas connecté
- clignotement rapide = batterie faible
- pulser = en charge

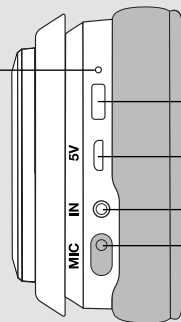

Bouton alimentation

Port de charge USB

Prise Mobile/Xbox Chat

Prise Micro

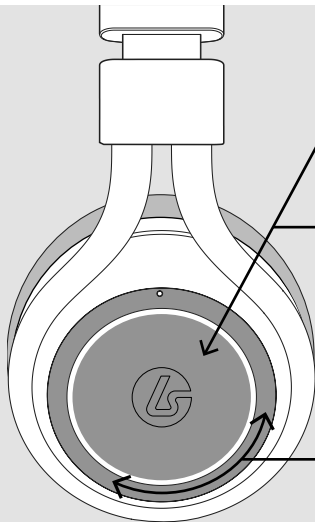

[D]

**Mic Monitoring**

Mic Monitor Marche/Arrêt = Appuyez pendant 3 secondes

**Mic Mute**

Marche/Arrêt = Pression courte

La DEL du micro s'allume en mode muet

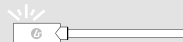
**Volume Chat****Select du mode EQ**

- 1 bip = neutre
- 2 bips = basses amplifiées
- 3 bips = aigus amplifiés

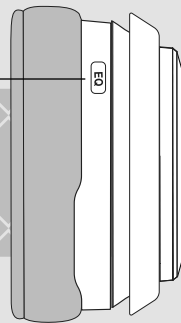



1

**Micro externe**

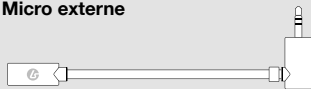

3

**Câble de recharge USB**

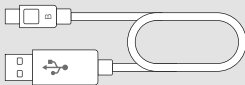

5

**Couverture du prise micro externe**



2

**Câble Optique**

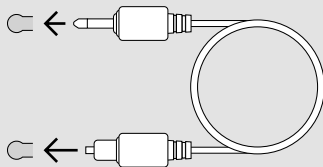

4

**Câble Xbox Chat / Mobile 3,5mm**

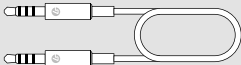

**État DEL**

allumé = connecté  
clignoté = pas connecté

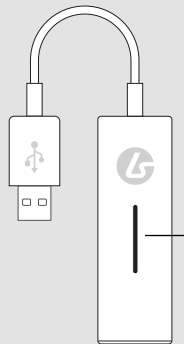

**Entrée Optique**

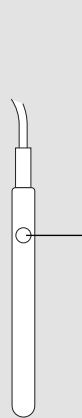

FR

# CHARGEMENT



pulser = en charge  
allumé = chargée

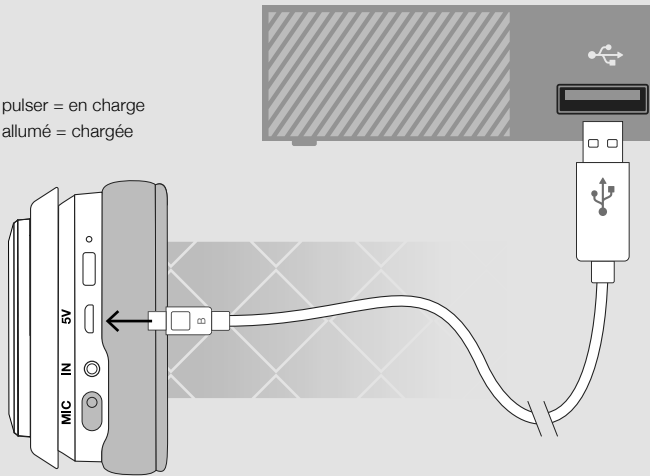

# MICRO EXTERNE

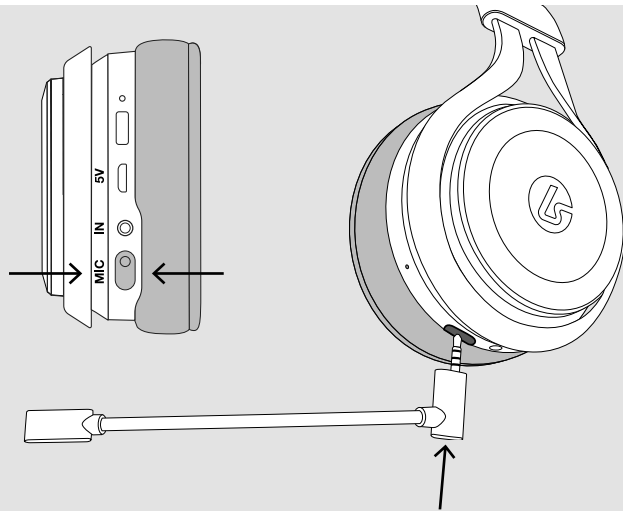

# INSTALLATION PLAYSTATION 4



FR

## PS4 et PS4 PRO

**!!! IMPORTANT !!!**

Pour terminer l'installation pour PS4 (original) et PS4 Pro, aller à:



<https://bit.ly/2tuC3FW>

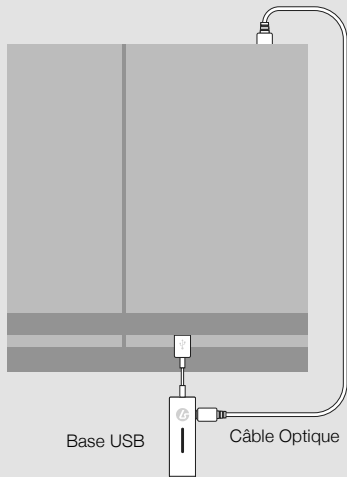

## PS4 Slim

télévision

Câble Optique

Base USB

**!!! IMPORTANT !!!**

Pour terminer l'installation pour PS4 Slim, aller à:

<https://bit.ly/2KpZMla>



FR

# INSTALLATION XBOX ONE

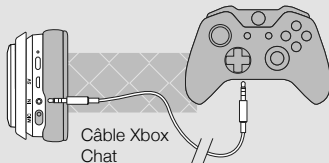
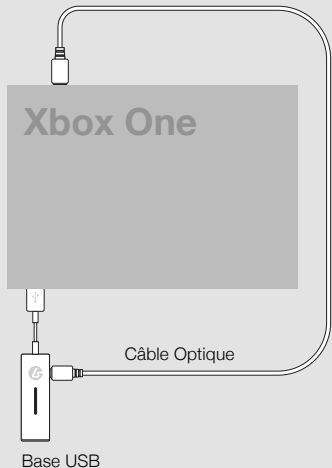

**!!! IMPORTANT !!!**

Pour terminer l'installation  
pour Xbox One, aller à:



<https://bit.ly/2lDe5or>

# INSTALLATION PC / MAC



**!!! IMPORTANT !!!**

Pour des instructions d'installation  
détaillées pour PC / Mac, allez à:

<https://bit.ly/2KnD7pp>



# MOBILE



Avec le casque éteint, Connecter le câble mobile sur le port 3,5mm du casque et l'autre extrémité sur le port 3,5mm de l'appareil mobile. Les commandes de volume et de sourdine ne fonctionnent pas dans ce mode.

**Model No:** LS31RX**IC:** 21203-06302**LucidSound, Inc.****Model No:** LS31TX**IC:** 21203-06301

Fabriqué en Chine

Fréquence RF: 2.40335 GHz à 2.47935 GHz

Puissance de sortie: TX = 5.83 dBm RX = 3.58 dBm

Fabricant: LucidSound, Inc.

Importateur: des informations peuvent être trouvées chez [lucidsound.com](http://lucidsound.com)

Le manuel d'utilisation des appareils radio exempts de licence doit contenir l'énoncé qui suit, ou l'équivalent, à un endroit bien en vue et/ou sur les appareils :

Le présent appareil est conforme aux CNR d'Industrie Canada applicables aux appareils radio exempts de licence. L'exploitation est autorisée aux deux conditions suivantes : (1) l'appareil ne doit pas produire de brouillage, et (2) l'utilisateur de l'appareil doit accepter tout brouillage radioélectrique subi, même si le brouillage est susceptible d'en compromettre le fonctionnement.

**Déclaration d'exposition à la radiation:**

Cet équipement respecte les limites d'exposition aux rayonnements IC RSS-102 définies pour un environnement non contrôlé. Cet équipement doit être installé et mis en marche à une distance minimale de 0.5 cm qui sépare l'élément rayonnant de votre corps.

**DEEE (directive sur les déchets d'équipements électriques et électroniques)**

Cet équipement respecte les limites d'exposition aux rayonnements IC RSS-102 définies pour un environnement non contrôlé. Cet équipement doit être installé et mis en marche à une distance minimale de 0.5 cm qui sépare l'élément rayonnant de votre corps.

**RoHS**

Ce produit a été certifié conforme RoHS conformément à la directive 2011/65 / CE.

**Mise au rebut des batteries / batteries rechargeables**

Veillez suivre les directives régionales pour l'élimination des piles rechargeables ou contacter les autorités locales, votre service d'élimination des déchets ménagers ou le magasin où vous avez acheté le produit. Les piles / piles rechargeables ne doivent pas être jetées dans les ordures ménagères normales. Veuillez utiliser une batterie rechargeable dans votre quartier ou votre communauté, si disponible.

**DÉCLARATION DE CONFORMITÉ DE L'UE**

Par la présente, nous garantissons que snakebyte distribution GmbH, située au 13 Konrad-Zuse-Str., Schwerte 58239 Allemagne, commercialise cet appareil LS40 sous la marque LucidSound et répond aux exigences légales et aux exigences de la directive 2014/53 / UE. Cette notification est répertoriée sous:

[lucidsound.com/EUDOC](http://lucidsound.com/EUDOC)

**Garantie**

Lucid Sound Inc garantit ce produit contre tout défaut de matériau ou de fabrication durant la période de garantie. Cette garantie limitée non transférable n'est valable que pour le premier acheteur du produit. Si un défaut couvert par cette garantie survient ET si vous avez la preuve d'achat du produit, Lucid Sound Inc, procèdera, à sa discrétion, au remplacement ou à la réparation du produit à sa charge (excepte les frais d'envoi à Lucid Sound).

La garantie limitée de 2 ans offerte par Lucid Sound Inc, est valable pour les clients Européens (Canada: 1 an). Le seul et unique remède est la réparation ou le remplacement de votre produit Lucid Sound. En aucun cas la responsabilité de Lucid Sound ne pourra excéder le montant initial d'achat du produit. Cette garantie ne s'applique pas à : (a) Usure normale due à l'utilisation ou utilisation abusive ; (b) usage industriel, professionnel ou commercial ; (c) Si le produit a été modifié ou démonté.

**Pour recevoir le service de garantie s'il vous plaît nous contacter à : [lucidsound.com](http://lucidsound.com)**

© 2018 Lucid Sound, Inc. 701 Palomar Airport Rd., Suite 230, Carlsbad, CA 92011 USA. Lucid Sound et le logo Lucid Sound sont des marques de commerce de Lucid Sound, Inc., de ses filiales et de ses sociétés affiliées. La forme et la conception de ce produit sont un habillage commercial de Lucid Sound, Inc., de ses filiales et de ses sociétés affiliées. Tous les droits sont réservés. Tous les autres noms de produits et images sont des marques commerciales ou des marques déposées de leurs propriétaires respectifs. Fabriqué en Chine. Les caractéristiques, l'apparence et les spécifications du produit peuvent faire l'objet de modifications sans préavis. Veuillez conserver cette information pour référence ultérieure.





[L]

**Power/Aufladen LED**

Durchgehendes Leuchten = EIN/verbunden/Aufladen

Langsames Blinken = Verbindungssuche

Schnelles Blinken = Akku schwach

Pulsierend = Laden

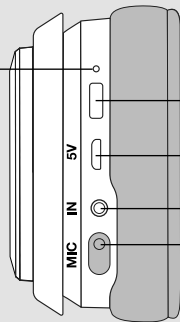
**Gamesound aus/stumm****Lautstärke Gamesound****Power-Koppeln Taste****USB-Ladeanschluss****Mobile/Xbox Input****Mikrofonanschluss**



[R]

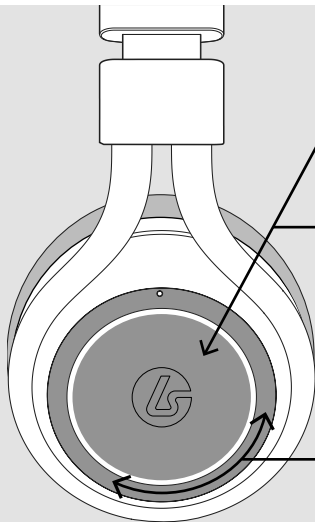

## Mikrofonmonitor

Mikrofonmonitor aus/stumm = Drücken Sie für 3 Sekunden

## Mikrofon aus/stumm

Mute/Unmute = Kurz drücken

LED am Mikrofonarm leuchtet, wenn das Mikrofon stumm geschaltet ist

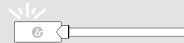

## Lautstärke Chat

## EQ Modus Wahl

- 1 Pieptöne = Normal
- 2 Pieptöne = Bass Boost
- 3 Pieptöne = Höhen Boost

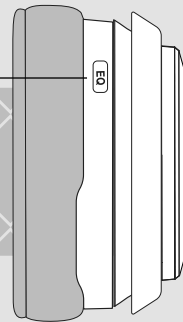



1

## Mikrofonarm

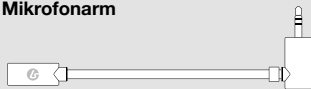

3

## Micro USB Ladekabel

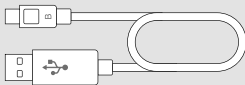

5

Mikrofonan-  
schluss Kappe

2

## Optisches Kabel

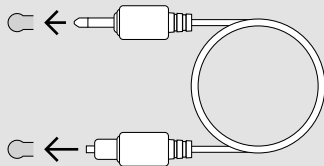

4

## Kabel für Mobil / Xbox Chat

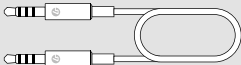

## Status LED

Durchgehendes Leuchten = verbunden

Blinken = Verbindungssuche

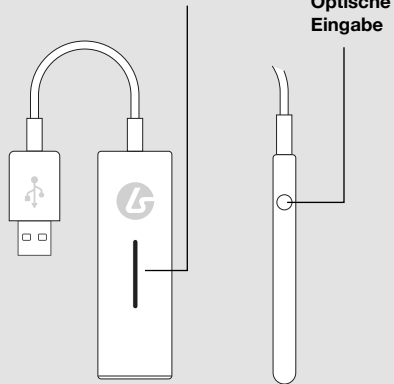

# LADEVORGANG



Pulsieren = Laden  
Solid = geladen

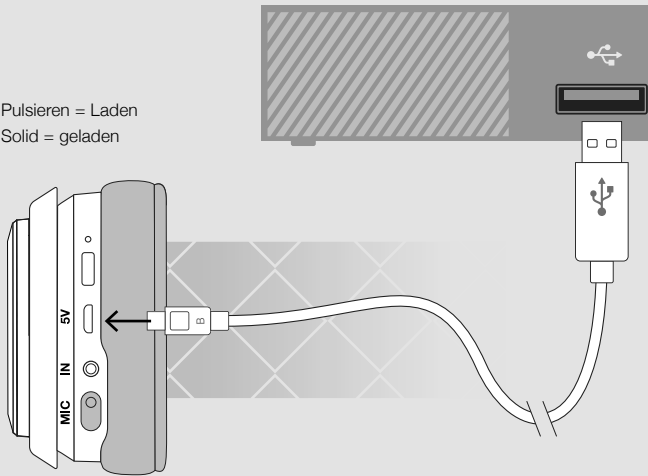

# MIKROFON



DE

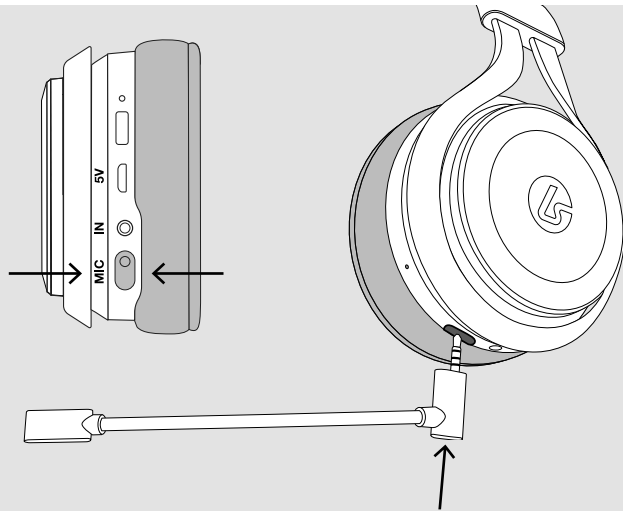

## PS4 und PS4 PRO

**!!! WICHTIG !!!**

Um das Setup für PS4 (Original) und PS4 Pro abzuschließen, gehe zu:



<https://bit.ly/2tuC3FW>

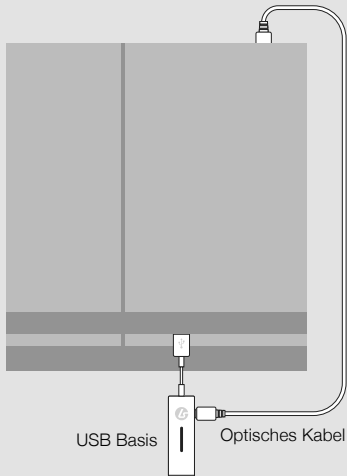

## PS4 Slim

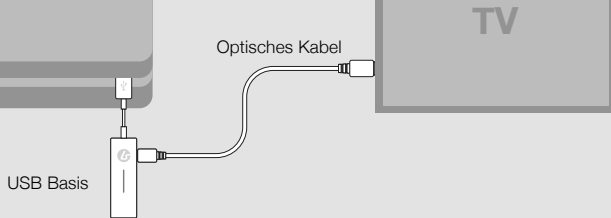
**!!! WICHTIG !!!**

Um das Setup für PS4 Slim abzuschließen, gehe zu:



<https://bit.ly/2KpZMla>

# XBOX ONE SETUP

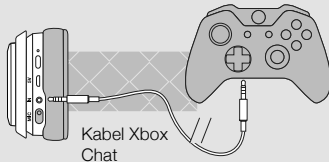
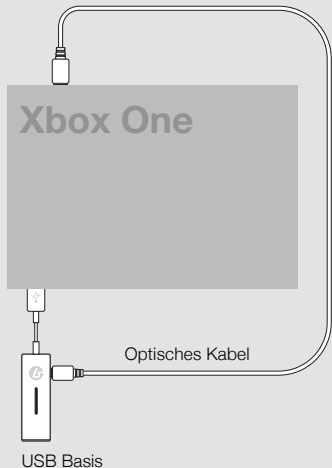

## !!! WICHTIG !!!

Um das Setup für Xbox One abzuschließen, gehe zu:



<https://bit.ly/2lDe5or>

# PC / MAC SETUP



DE

## !!! WICHTIG !!!

Für detaillierte Setup-Anweisungen für PC / Mac gehen Sie zu:

<https://bit.ly/2KnD7pp>



# MOBILE GERÄTE



Schließen Sie bei ausgeschaltetem Headset das 3,5-mm-Mobilkabel zwischen dem Headset und dem Telefon an. Die Lautstärkeregelung und die Stummschaltung funktionieren in diesem Modus nicht.

**Modell Nr:** LS31RX**IC:** 21203-06302**LucidSound, Inc.****Modell Nr:** LS31TX**IC:** 21203-06301

In China hergestellt

HF-Frequenz: 2.40335 GHz bis 2.47935 GHz

Ausgangsleistung: TX = 5.83 dBm RX = 3.58 dBm

Hersteller: LucidSound, Inc.

Importeur: Informationen finden Sie unter [lucidsound.com](http://lucidsound.com)**WEEE (Richtlinie über Elektro- und Elektronik-Altgeräte)**

Wenn Sie dieses Produkt zu einem späteren Zeitpunkt entsorgen möchten, beachten Sie bitte folgende Hinweise: Elektronische Geräte dürfen nicht mit dem Hausmüll entsorgt werden. Bitte recyceln Sie das Gerät, wenn Ihnen die entsprechenden Recyclingmöglichkeiten zur Verfügung stehen. Bitte wenden Sie sich an Ihre örtliche Behörde oder Ihren Händler und fragen Sie nach einem Recycling-Rat.

**RoHS**

Dieses Produkt wurde gemäß der Richtlinie 2011/65 / CE als RoHS-konform zertifiziert.

**Entsorgung von Batterien / Akkus**

Bitte beachten Sie die regionalen Richtlinien zur Entsorgung von Akkus oder wenden Sie sich an die örtlichen Behörden, Ihren Hausmüll-Entsorgungsdienst oder das Geschäft, in dem Sie das Produkt erworben haben. Batterien / Akkus dürfen nicht in den normalen Hausmüll gegeben werden. Bitte verwenden Sie eine wiederaufladbare Batterie in Ihrer Nachbarschaft oder Gemeinde, falls verfügbar.

**KONFORMITÄTSERKLÄRUNG**

Hiermit erklärt snakebyte distribution GmbH, Konrad-Zuse-Str. 13, Schwerte 58239 Germany, dass dieses Produkt den grundlegenden Anforderungen und anderen relevanten Auflagen der Richtlinien 2014/53/EU entspricht, soweit zutreffend. Die gemäß dem Konformitätsbewertungsverfahren erforderlichen technischen Unterlagen können an folgender Stelle eingesehen werden:

[lucidsound.com/EUDOC](http://lucidsound.com/EUDOC)

Lucid Sound, Inc. garantiert, dass dieses Produkt frei von Mängeln in Material und Verarbeitung für den Garantiezeitraum ist. Diese nicht übertragbare, 2 Jahre Garantie (Canada: 1 Jahre Garantie) ist nur für Sie, den ersten Käufer und Endbenutzer. Soweit ein Mangel, der von dieser Garantie gedeckt wird, auftritt und Sie über einen Nachweis über den Kauf des Produkt verfügen, wird Lucid Sound, Inc. nach eigenem Ermessen entweder reparieren oder das Produkt kostenlos (ohne Versandkosten zu Lucid Sound) ersetzen.

Die Lucid Sound, Inc. 2 Jahre Garantie ist für Kunden in Europe verfügbar (Canada: 1 Jahre). Die einzige und ausschließliche Abhilfe ist Reparatur oder der Ersatz Ihres Lucid Sound Produkts. In keinem Fall überschreitet die Haftung von Lucid Sound, Inc. den ursprünglichen Kaufpreis des Produkts. Diese Garantie gilt nicht für: (a) normalen Verschleiß oder Missbrauch; (b) Industrie, berufliche oder kommerzielle Zwecke; (c) wenn das Produkt manipuliert oder verändert wurde.

**Um Garantieservice zu erhalten kontaktieren Sie uns bitte wie folgt: [lucidsound.com](http://lucidsound.com)**



[S]



**Silenziamento Gioco**

**Volume Gioco**

## LED di accensione

Fisso = ON / connesso / carica

Blink Lento = no collegata

Blink Veloce = Batteria scarica

Pulsante = Ricarica

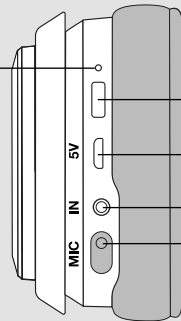

**Tasto di accensione**

**Porta di ricarica USB**

**Porta Xbox Chat / Mobile**

**Porta Microfono**



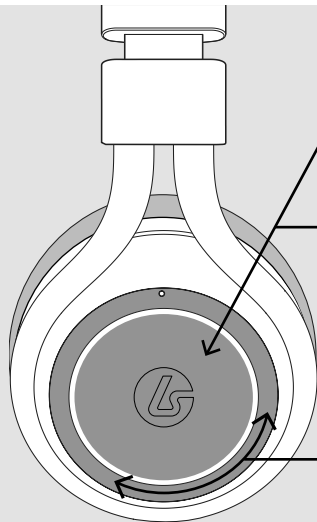

[D]

**Funzione “Mic-monitoring”**

Mic Monitoring Disattivato/Riattivato =  
premere per 3 secondi

**Silenziamento Microfono**

Disattivato/Riattivato = Breve Pres-  
sione

LED sul microfono si accende quando  
disattivato

**Volume Chat****Mode Selezionare EQ**

- 1 bip = Normale
- 2 bip = Incremento Basses
- 3 bips = Incremento Treble

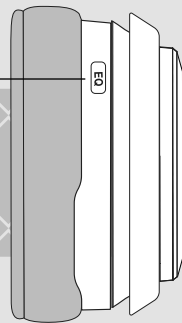



1

**Microfono a braccio**

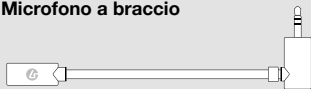

2

**Cavo Ottico**

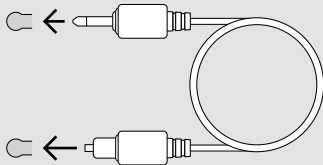

3

**Cavo di ricarica USB**

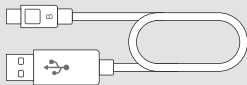

5

**Coperchio della porta Mic**



4

**Cavo Xbox Chat / Mobile**

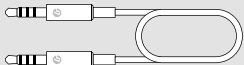

**LED di stato**

Solido = Connesso

Blink lento = No collegata

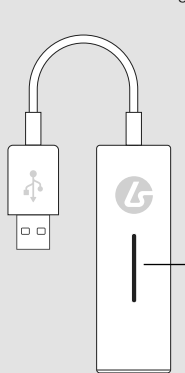

**Ingresso Ottico**

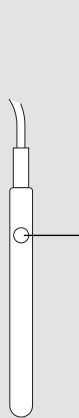

IT

# RICARICA



Pulsante = Ricarica  
Fisso = Carica

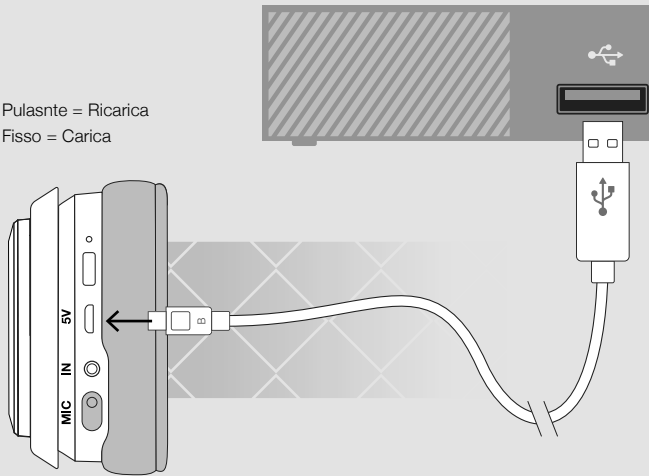

# MICROFONO

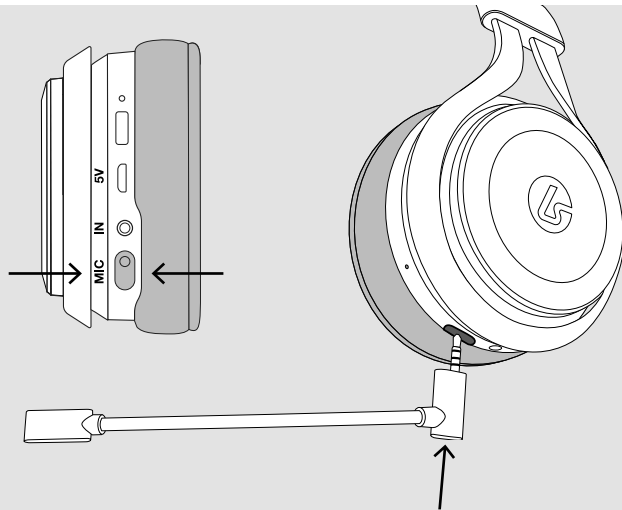

# CONFIGURAZIONE PLAYSTATION 4



IT

## PS4 e PS4 PRO

**!!! IMPORTANTE !!!**

Per completare l'installazione di PS4 (originale) e PS4 Pro, vai a:



<https://bit.ly/2tuC3FW>

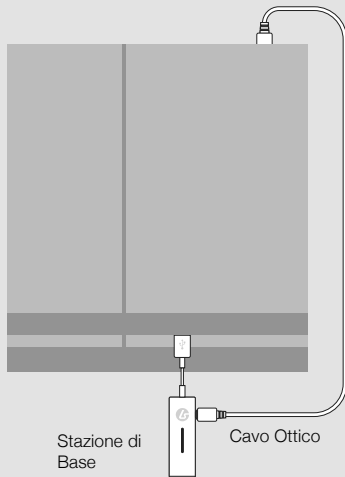

## PS4 Slim

Stazione di Base

Cavo Ottico

TV

**!!! IMPORTANTE !!!**

Per completare l'installazione di PS4 Slim, vai a:

<https://bit.ly/2KpZMla>



IT

## CONFIGURAZIONE XBOX ONE



### !!! IMPORTANTE !!!

Per completare l'installazione di Xbox One, vai a:



<https://bit.ly/2lDe5or>

## CONFIGURAZIONE PC / MAC



### !!! IMPORTANTE !!!

Per istruzioni dettagliate sulla configurazione per PC / Mac, vai a:

<https://bit.ly/2KnD7pp>



## CONFIGURAZIONE CELLULARE



Con la cuffia spenta, collegare il cavo Mobile da 3,5 mm tra l'auricolare e il telefono. I controlli volume e muto non funzionano in questa modalità.

**Modello No:** LS31RX  
**Modello No:** LS31TX

**IC:** 21203-06302  
**IC:** 21203-06301

**LucidSound, Inc.**  
Fatto in Cina

Frequenza RF: 2.40335 GHz a 2.47935 GHz  
Potenza di uscita: TX = 5.83 dBm RX = 3.58 dBm  
Produttore: LucidSound, Inc.  
Importatore: informazioni possono essere trovate su [lucidsound.com](http://lucidsound.com)

Non tentare di sostituire la batteria: potrebbe danneggiare la batteria, che potrebbe causare surriscaldamento, incendio e lesioni. La batteria agli ioni di litio nella cuffia deve essere riparata o riciclata da LucidSound o da un prestatore di servizi autorizzato e deve essere riciclato o smaltito separatamente dai rifiuti domestici. Smaltire le batterie in base alle leggi e alle linee guida ambientali locali.



#### **DIRETTIVA RAE (RIFIUTI DI APPARECCHIATURE ELETTRICHE ED ELETTRONICHE)**

Se si desidera eliminare questo prodotto in un secondo momento, si prega di osservare le seguenti istruzioni: Le apparecchiature elettroniche non devono essere smaltite insieme ai rifiuti domestici. Si prega di riciclare il dispositivo se sono disponibili le modalità di riciclaggio appropriate. Si prega di contattare l'autorità locale o il rivenditore e chiedere loro consigli sul riciclaggio.

#### **RoHS**

Questo prodotto è stato certificato come conforme alla Direttiva RoHS in conformità alla Direttiva 2011/65 / CE.

#### **Smaltimento di batterie / batterie ricaricabili**

Seguire le linee guida regionali per lo smaltimento delle batterie ricaricabili o contattare le autorità locali, il servizio di smaltimento dei rifiuti domestici o il negozio in cui è stato acquistato il prodotto. Le batterie / le batterie ricaricabili non devono essere smaltite nei normali rifiuti domestici. Si prega di utilizzare uno smaltimento della batteria ricaricabile nel proprio quartiere o comunità, se disponibile.



#### **EU DECLARATION OF CONFORMITY**



Con la presente garantiamo che snakebyte distribution GmbH, con sede in 13 Konrad-Zuse-Str., Schwerte 58239 Germania, commercializza questo dispositivo LS40 con il marchio LucidSound e soddisfa i requisiti legali e i requisiti della direttiva 2014/53 / UE. Questa notifica è elencata sotto:  
[lucidsound.com/EUDOC](http://lucidsound.com/EUDOC)

#### **Garanzia**

LucidSound, Inc. garantisce che questo prodotto è privo di difetti in materiali e manodopera per il periodo di garanzia. Questa garanzia limitata, non trasferibile, di 2 anni è solo per voi, il primo utente finale acquirente. Se un difetto coperto da questa garanzia si verifica E potete fornire la ricevuta di acquisto, Lucid Sound, Inc., a sua discrezione, riparerà o sostituirà il prodotto gratuitamente (escluso il trasporto a Lucid Sound).

Lucid Sound, Inc., garanzia limitata di 2 anni di è disponibile per i clienti europei (Canada: 1 anno). L'unico ed esclusivo rimedio è la riparazione o la sostituzione del prodotto Lucid Sound. In nessun caso la responsabilità di Lucid Sound può essere superiore al prezzo di acquisto originale del prodotto. Questa garanzia non si applica a: (a) normale usura o uso abusivo; (b), l'uso professionale, commerciale o industriale; (c) se il prodotto è stato manomesso o modificato.

**Per ricevere assistenza in garanzia, vi preghiamo di contattarci all'indirizzo:**

**[lucidsound.com](http://lucidsound.com)**



[1]

**Encendido/Carga LED**

Luz fija = ON/Conectado/Cargado

LED parpadea = No conectado

LED parpadeo-rápido = Baja batería

Pulsando = Cargando

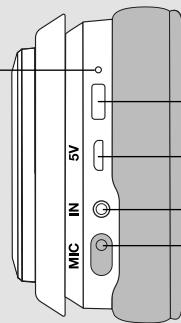
**Función Mute Juego****Volumen Juego****Botón de encendido****Puerto de carga USB****Entrada Xbox Chat / Móvil****Entrada Micrófono**



[D]

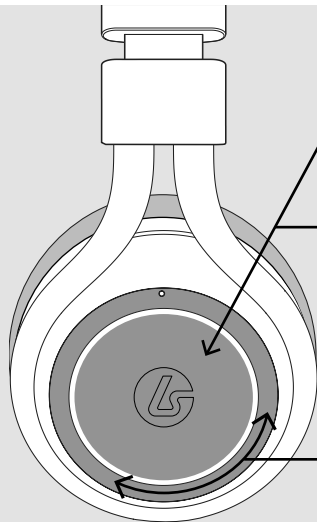

## Control monitorizado del microfono

Encendido / Apagado = Presionar durante 3 segundos

## Función Mute Micrófono

Sonido / Silenciado = Pulsación corta

El LED del micrófono se ilumina cuando está en función mute

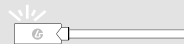

## Volumen del Chat

## Selector de Modo EQ

- 1 pitido = Normal
- 2 pitidos = Realce de graves
- 3 pitidos = Realce de agudos

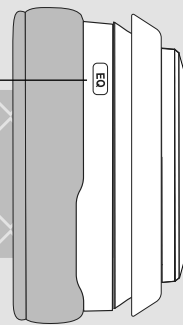





1

Brazo de micro

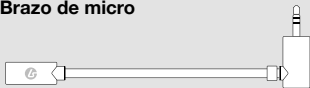

2

Cable óptico

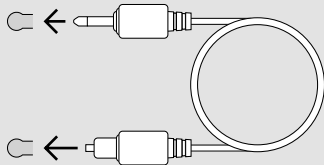

3

Cable de Carga Micro USB

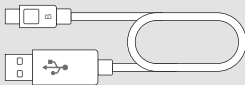

4

Cable de Xbox Chat / Mobile

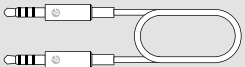

5

Puerto de micro cubierto



Indicador LED

Luz fija = Conectado  
LED parpadea = No conectado

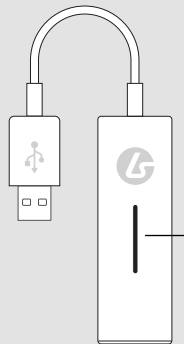

Entrada Cable Óptico

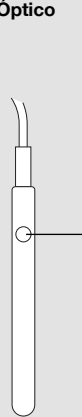

# CARGA



LED parpadea = Cargando  
Luz fija = Cargado

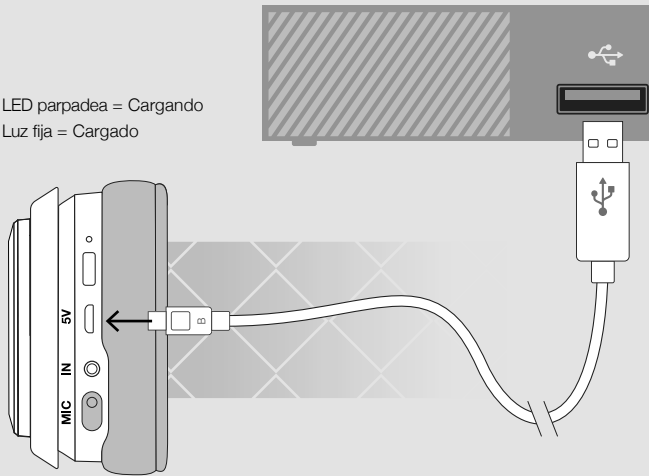

# MICRÓFONO



ES

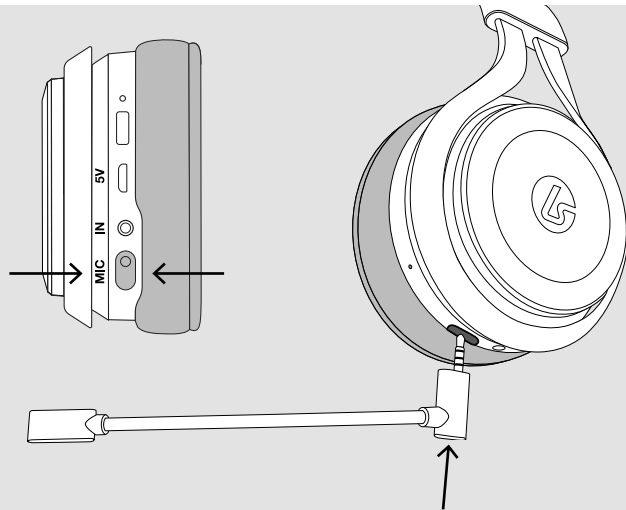

ES

# CONFIGURACIÓN PLAYSTATION 4



## PS4 y PS4 PRO

**!!! IMPORTANTE !!!**

Para completar la configuración de PS4 (original) y PS4 Pro, vaya a:



<https://bit.ly/2tuC3FW>

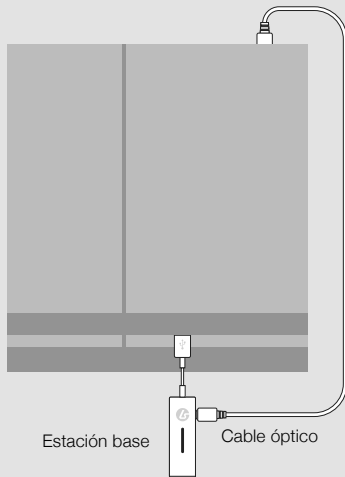

## PS4 Slim

TV

**!!! IMPORTANTE !!!**

Para completar la configuración de PS4 Slim, vaya a:



<https://bit.ly/2KpZMla>

# CONFIGURACIÓN XBOX ONE

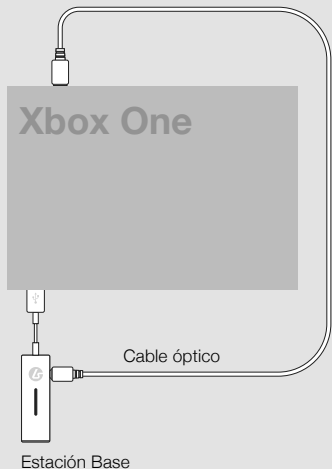

## !!! IMPORTANTE !!!

Para completar la configuración de Xbox One, vaya a:



<https://bit.ly/2lDe5or>

# CONFIGURACIÓN PC / MAC



ES

## !!! IMPORTANTE !!!

Para obtener instrucciones de configuración detalladas para PC / Mac, vaya a:

<https://bit.ly/2KnD7pp>



# MÓVILES



Con los auriculares apagados, conecte el cable móvil de 3.5 mm entre los auriculares y el teléfono. Los controles de volumen y silencio no funcionan en este modo.

**Model No:** LS31RX**IC:** 21203-06302**LucidSound, Inc.****Model No:** LS31TX**IC:** 21203-06301

Hecho en China

Frecuencia de RF: 2.40335 GHz a 2.47935 GHz

Potencia de salida: TX = 5.83 dBm RX = 3.58 dBm

Fabricante: LucidSound, Inc.

Importador: La información se puede encontrar en [lucidsound.com](http://lucidsound.com)**RAEE (Directiva sobre residuos de aparatos eléctricos y electrónicos)**

Si finalmente desea desechar este producto más adelante, tenga en cuenta las siguientes instrucciones: El equipo electrónico no se debe tirar junto con la basura doméstica. Recicle el dispositivo si dispone de las formas de reciclaje adecuadas. Comuníquese con su autoridad local o minorista y solicite asesoramiento sobre reciclaje.

**RoHS**

Este producto ha sido certificado como RoHS conforme a la Directiva 2011/65 / CE.

**Eliminación de baterías / baterías recargables**

Siga las pautas regionales para la eliminación de baterías recargables o comuníquese con las autoridades locales, el servicio de eliminación de desechos domésticos o la tienda donde compró el producto. Las baterías / baterías recargables no deben desecharse en la basura doméstica normal. Utilice una eliminación de batería recargable en su vecindario o comunidad, si está disponible.

**DECLARACIÓN DE CONFORMIDAD DE LA UE**

De esta manera garantizamos que snakebyte distribution GmbH, ubicada en 13 Konrad-Zuse-Str., Schwerte 58239 Alemania, está comercializando este dispositivo LS40 bajo la marca LucidSound y cumple con los requisitos legales y los requisitos de la Directiva 2014/53 / EU. Esta notificación se encuentra debajo de:

[lucidsound.com/EUDOC](http://lucidsound.com/EUDOC)

Lucid Sound, Inc. garantiza los materiales y mano de obra durante el periodo de garantía del producto. Esto no es transferible, la garantía tiene una limitación de 2 años (Canada: 1 año). Importante! sólo podrá ser utilizada por el al usuario final. Cualquier defecto será cubierto bajo esta garantía. Es necesario presentar el comprobante de compra. Lucid Sound, Inc., reparará o reemplazará el producto sin cargos (Como excepción la compañía no se hará cargo del coste del envío en tu dirección del auricular Lucid Sound).

La garantía limitada de 2 años será para los clientes europeos (Canada: 1 año). Su único, y exclusivo derecho es la reparación o sustitución de su producto Lucid Sound. En ningún caso la responsabilidad de auricular Lucid Sound excederá del precio de compra original del producto. Esta garantía no se aplica a : ( a ) el desgaste normal o el uso abusivo; ( b ) el uso industrial , comercial o profesional ; ( c ) si el producto ha sido manipulado o modificado previamente.

Para recibir la garantía, por favor contacte con nosotros en: **[lucidsound.com](http://lucidsound.com)**

